

Appendix F-3

(Site 3 - South Nance East)
Project Specific Preliminary Water Quality
Management Plan,
Perris Trailer Yard Nance Street

Thienes Engineering, Inc.
February 23, 2023



Thienes Engineering, Inc.
CIVIL ENGINEERING • LAND SURVEYING

**PROJECT SPECIFIC PRELIMINARY
WATER QUALITY MANAGEMENT PLAN
(P-WQMP)**

FOR:
P23-XXXXX
PERRIS TRAILER YARD
NANCE STREET
PERRIS, CALIFORNIA 92571
APNs: 314-160-016, 314-160-017 AND 314-160-018

PREPARED FOR:
LAKE CREEK INDUSTRIAL, LLC
1302 BRITTANY CROSS ROAD
SANTA ANA, CALIFORNIA 92705
PHONE: (949) 910-4616
CONTACT: BOB KUBICHEK

FEBRUARY 23, 2023

JOB NO. 4130

PREPARED BY:
THIENES ENGINEERING, INC.
14349 FIRESTONE BLVD.
LA MIRADA, CALIFORNIA 90638
PHONE: (714) 521-4811
FAX: (714) 521-4173
CONTACT: LUIS PRADO (luisp@thieneseng.com)

**PROJECT SPECIFIC PRELIMINARY
WATER QUALITY MANAGEMENT PLAN
(P-WQMP)**

FOR

“PERRIS TRAILER YARD”



PREPARED BY LUIS PRADO
UNDER THE SUPERVISION OF:

REINHARD STENZEL
R.C.E. 56155
EXP. 12/31/2024

2/23/2023
DATE

Project Specific Water Quality Management Plan

A Template for Projects Located within the **Santa Ana Watershed** Region of Riverside County

Project Title: Perris Trailer Yard

Development No: Nance Street

Design Review/Case No: P23-XXXXX

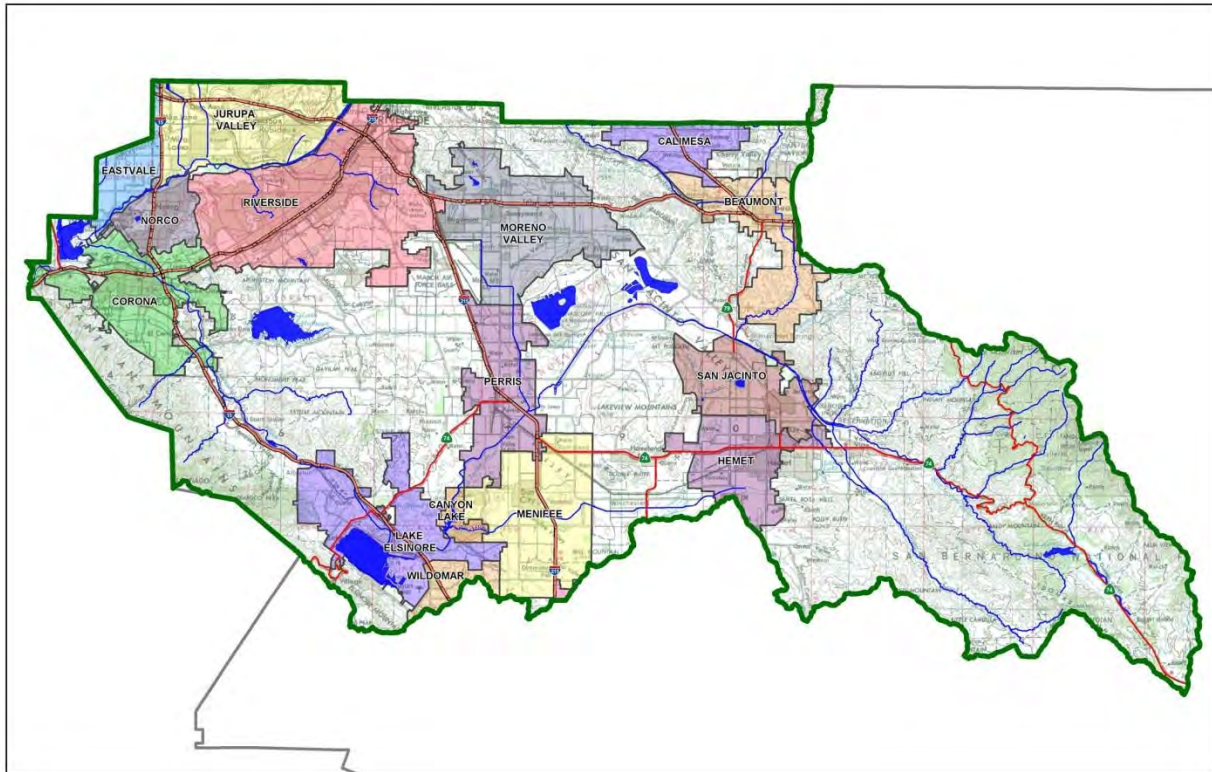

Contact Information:

Prepared for:

Lake Creek Industrial, LLC
1302 Brittany Cross Road
Santa Ana, California, 92705
Phone: (949) 910-4616
Contact: Bob Kubichek

Prepared by:

Thienes Engineering, Inc.
14349 Firestone Boulevard
La Mirada, CA 90638
(714) 521-4811
Contact: Luis Prado (luisp@thieneseng.com)
Job No. 4130

- Preliminary
- Final

Original Date Prepared: February 23, 2023

Revision Date(s):

Prepared for Compliance with

*Regional Board Order No. **R8-2010-0033***

A Brief Introduction

This Project-Specific WQMP Template for the **Santa Ana Region** has been prepared to help guide you in documenting compliance for your project. Because this document has been designed to specifically document compliance, you will need to utilize the WQMP Guidance Document as your “how-to” manual to help guide you through this process. Both the Template and Guidance Document go hand-in-hand, and will help facilitate a well prepared Project-Specific WQMP. Below is a flowchart for the layout of this Template that will provide the steps required to document compliance.

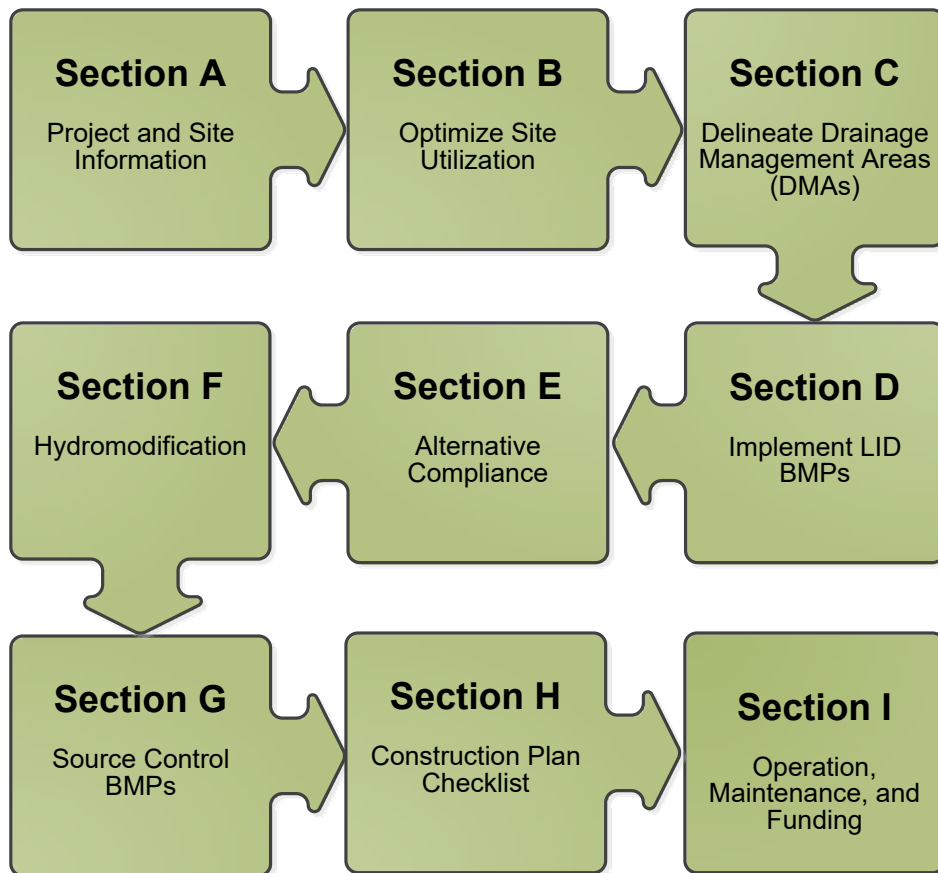

OWNER'S CERTIFICATION

This Project-Specific Water Quality Management Plan (WQMP) has been prepared for **Lake Creek Industrial, LLC** by **Thienes Engineering, Inc.** for the **Perris Trailer Yard** project (P23-XXXXX).

This WQMP is intended to comply with the requirements of **City of Perris** for **Ordinance No. 1194** which includes the requirement for the preparation and implementation of a Project-Specific WQMP.

The undersigned, while owning the property/project described in the preceding paragraph, shall be responsible for the implementation and funding of this WQMP and will ensure that this WQMP is amended as appropriate to reflect up-to-date conditions on the site. In addition, the property owner accepts responsibility for interim operation and maintenance of Stormwater BMPs until such time as this responsibility is formally transferred to a subsequent owner. This WQMP will be reviewed with the facility operator, facility supervisors, employees, tenants, maintenance and service contractors, or any other party (or parties) having responsibility for implementing portions of this WQMP. At least one copy of this WQMP will be maintained at the project site or project office in perpetuity. The undersigned is authorized to certify and to approve implementation of this WQMP. The undersigned is aware that implementation of this WQMP is enforceable under **City of Perris Ordinance No. 1194**.

"I, the undersigned, certify under penalty of law that the provisions of this WQMP have been reviewed and accepted and that the WQMP will be transferred to future successors in interest."

Owner's Signature

Date

Owner's Printed Name

Owner's Title/Position

PREPARER'S CERTIFICATION

"The selection, sizing and design of stormwater treatment and other stormwater quality and quantity control measures in this plan meet the requirements of Regional Water Quality Control Board Order No. **R8-2010-0033** and any subsequent amendments thereto."

Preparer's Signature

Date

Reinhard Stenzel
Preparer's Printed Name

Director of Engineering
Preparer's Title/Position

Preparer's Licensure:

Table of Contents

Section A: Project and Site Information	6
A.1 Maps and Site Plans.....	7
A.2 Identify Receiving Waters.....	7
A.3 Additional Permits/Approvals required for the Project:	8
Section B: Optimize Site Utilization (LID Principles)	9
Section C: Delineate Drainage Management Areas (DMAs).....	11
Section D: Implement LID BMPs	13
D.1 Infiltration Applicability	13
D.2 Harvest and Use Assessment	14
D.3 Bioretention and Biotreatment Assessment.....	17
D.4 Feasibility Assessment Summaries.....	17
D.5 LID BMP Sizing	18
Section E: Alternative Compliance (LID Waiver Program)	19
E.1 Identify Pollutants of Concern	20
E.2 Stormwater Credits.....	21
E.3 Sizing Criteria	22
E.4 Treatment Control BMP Selection	22
Section F: Hydromodification	23
F.1 Hydrologic Conditions of Concern (HCOC) Analysis.....	23
F.2 HCOC Mitigation	24
Section G: Source Control BMPs.....	25
Section H: Construction Plan Checklist.....	28
Section I: Operation, Maintenance and Funding.....	29

List of Tables

Table A.1 Identification of Receiving Waters.....	7
Table A.2 Other Applicable Permits.....	8
Table C.1 DMA Classifications.....	11
Table C.2 Type 'A', Self-Treating Areas.....	11
Table C.3 Type 'B', Self-Retaining Areas.....	11
Table C.4 Type 'C', Areas that Drain to Self-Retaining Areas.....	12
Table C.5 Type 'D', Areas Draining to BMPs.....	12
Table D.1 Infiltration Feasibility.....	13
Table D.2 LID Prioritization Summary Matrix.....	17
Table D.3 DCV Calculations for LID BMPs.....	18
Table E.1 Potential Pollutants by Land Use Type.....	20
Table E.2 Water Quality Credits.....	21
Table E.3 Treatment Control BMP Sizing.....	22
Table E.4 Treatment Control BMP Selection.....	22
Table F.1 Hydrologic Conditions of Concern Summary.....	23
Table G.1 Permanent and Operational Source Control Measures.....	25
Table H.1 Construction Plan Cross-reference.....	28

List of Appendices

Appendix 1: Maps and Site Plans.....	30
Appendix 2: Construction Plans.....	31
Appendix 3: Soils Information.....	32
Appendix 4: Historical Site Conditions.....	33
Appendix 5: LID Infeasibility.....	34
Appendix 6: BMP Design Details.....	35
Appendix 7: Hydromodification.....	36
Appendix 8: Source Control.....	37
Appendix 9: O&M.....	38
Appendix 10: Educational Materials.....	39

Section A: Project and Site Information

PROJECT INFORMATION	
Type of Project:	Light Industrial Warehouse
Planning Area:	Industrial/Business Park
Community Name:	N/A
Development Name:	Perris Trailer Yard
PROJECT LOCATION	
Latitude & Longitude (GIS): 33.855015, -117.246374	
Project Watershed and Sub-Watershed: Santa Ana River & San Jacinto	
APN(s): 314-160-016, 314-160-017 and 314-160-018	
Total Project Area: 2.73 acres	
Map Book and Page No.: Assessor's Map BK314 PG. 16	
PROJECT CHARACTERISTICS	
Proposed or Potential Land Use(s)	Light Industrial
Proposed or Potential SIC Code(s)	4225
Area of Existing Impervious Project Footprint (SF)	0
Total Area of <u>proposed</u> Impervious Surfaces within the Project Limits (SF)/or Replacement	114,563 (2.63 acres)
Does the project consist of offsite road improvements?	<input checked="" type="checkbox"/> Y <input type="checkbox"/> N
Does the project propose to construct unpaved roads?	<input type="checkbox"/> Y <input checked="" type="checkbox"/> N
Is the project part of a larger common plan of development (phased project)?	<input type="checkbox"/> Y <input checked="" type="checkbox"/> N
EXISTING SITE CHARACTERISTICS	
Total area of <u>existing</u> Impervious Surfaces within the project limits (SF)	0
Is the project located within any MSHCP Criteria Cell?	<input type="checkbox"/> Y <input checked="" type="checkbox"/> N
If so, identify the Cell number:	N/A
Are there any natural hydrologic features on the project site?	<input type="checkbox"/> Y <input checked="" type="checkbox"/> N
Is a Geotechnical Report attached?	<input checked="" type="checkbox"/> Y <input type="checkbox"/> N
If no Geotech. Report, list the NRCS soils type(s) present on the site (A, B, C and/or D)	Geotechnical Report Available
What is the Water Quality Design Storm Depth for the project?	0.611 inches

Project Description:

The project is located along the south side of Nance Street between Nevada Avenue and Webster Avenue. The project site encompasses approximately 2.73 acres. Proposed improvements include trailer/vehicle parking (109,164 SF) including a guard shack of 121 SF. Vehicle parking stalls will be located along Nance Street. Landscape areas (9,617 SF) will be located along the perimeter of the site.

Per the infiltration report, the two infiltration tests performed at the project site resulted in 0.0 inches per hour. Due to the poor infiltration characteristics of the on-site native soils at the tested depths, infiltration is not recommended. Based on these results, biotreatment BMPs such as the extended detention basin is feasible. However, the site is located within Riverside County's Airport Land Use Commission's (ALUC) jurisdiction; specifically, within Zone B1. ALUC guidelines ("Wildlife Hazard Management at Riverside County Airports: Background and Policy" dated October 2018, Table 5-4) specifically states that extended detention basins are prohibited in Zones A through D. As a result, the project proposes to use an equivalent underground biotreatment solution with an underground detention system (28 StormTech MC-3500 Chambers) and proprietary biotreatment unit (Bio Clean Modular Wetlands System; MWS-L-4-8-V) to treat runoff produced by the 85th percentile storm rainfall depth. Catch basin filters will be provided in order to pre-treat runoff prior to entering the water quality devices.

Existing Site:

The site is currently an undeveloped lot with sparse vegetation. The site generally sheet flows from west to east.

Hydrology:

In the proposed condition, the site will drain onto Nance Street which then continues surface draining easterly, similar to existing conditions. Runoff from the site will first drain to two catch basins; one located at the entrance of the site (along Nance Street) and the other on the east side of the trailer yard. A proposed onsite storm drain system will convey runoff northeasterly towards Nance Street. Runoff will ultimately exit the site via a parkway drain.

A portion of the driveway and landscaped area fronting Nance Street sheet flow offsite without being routed to LID BMPs. The landscaped areas are considered self-treating.

Offsite run-on along the westerly property line will be captured via two inlets and routed to the northeasterly corner – via a separate storm drain system – where run-on is then discharged offsite via a separate parkway drain.

Treated flows from the MWS will be pumped offsite via a separate parkway drain. Onsite and offsite flows trapped below the parkway drain’s spillover elevations will also get pumped offsite.

A.1 Maps and Site Plans

When completing your Project-Specific WQMP, include a map of the local vicinity and existing site. In addition, include all grading, drainage, landscape/plant palette and other pertinent construction plans in Appendix 2. At a **minimum**, your WQMP Site Plan should include the following:

- Drainage Management Areas
- Proposed Structural BMPs
- Drainage Path
- Drainage Infrastructure, Inlets, Overflows
- Source Control BMPs
- Buildings, Roof Lines, Downspouts
- Impervious Surfaces
- Standard Labeling

Use your discretion on whether or not you may need to create multiple sheets or can appropriately accommodate these features on one or two sheets. Keep in mind that the Co-Permittee plan reviewer must be able to easily analyze your project utilizing this template and its associated site plans and maps.

A.2 Identify Receiving Waters

Using Table A.1 below, list in order of upstream to downstream, and the receiving waters that the project site is tributary to. Continue to fill each row with the Receiving Water’s 303(d) listed impairments (if any), designated beneficial uses, and proximity, if any, to a RARE beneficial use. Include a map of the receiving waters in Appendix 1.

Table A.1 Identification of Receiving Waters

Receiving Waters	EPA Approved 303(d) List Impairments	Designated Beneficial Uses	Proximity to RARE Beneficial Use
RCB in N. Webster Avenue	None	None	Not classified as a RARE waterbody.
San Jacinto River, Reach 3	None	AGR, GWR, REC1, REC2, WARM, WILD	Not classified as a RARE waterbody.
Canyon Lake (aka San Jacinto River, Reach 2)	Nutrients	MUN, AGR, GWR, REC1, REC2, WARM, WILD	Not classified as a RARE waterbody.
San Jacinto River, Reach 1	None	MUN, AGR, GWR, REC1, REC2, WARM, WILD	Not classified as a RARE waterbody.

Receiving Waters	EPA Approved 303(d) List Impairments	Designated Beneficial Uses	Proximity to RARE Beneficial Use
Lake Elsinore	DDT, Nutrients, Organic Enrichment/Low Dissolved Oxygen, PCBs, Toxicity	REC1, REC2, WARM, WILD	Not classified as a RARE waterbody.

A.3 Additional Permits/Approvals required for the Project:

Table A.2 Other Applicable Permits

Agency	Permit Required	
State Department of Fish and Game, 1602 Streambed Alteration Agreement	<input type="checkbox"/> Y	<input checked="" type="checkbox"/> N
State Water Resources Control Board, Clean Water Act (CWA) Section 401 Water Quality Cert.	<input type="checkbox"/> Y	<input checked="" type="checkbox"/> N
US Army Corps of Engineers, CWA Section 404 Permit	<input type="checkbox"/> Y	<input checked="" type="checkbox"/> N
US Fish and Wildlife, Endangered Species Act Section 7 Biological Opinion	<input type="checkbox"/> Y	<input checked="" type="checkbox"/> N
Statewide Construction General Permit Coverage	<input checked="" type="checkbox"/> Y	<input type="checkbox"/> N
Statewide Industrial General Permit Coverage (dependent on tenant)	<input checked="" type="checkbox"/> Y	<input type="checkbox"/> N
Western Riverside MSHCP Consistency Approval (e.g., JPR, DBESP)	<input type="checkbox"/> Y	<input checked="" type="checkbox"/> N
Other (please list in the space below as required) City of Perris Grading Permit	<input checked="" type="checkbox"/> Y	<input type="checkbox"/> N
Other (please list in the space below as required) City of Perris Building Permit	<input checked="" type="checkbox"/> Y	<input type="checkbox"/> N

If yes is answered to any of the questions above, the Co-Permittee may require proof of approval/coverage from those agencies as applicable including documentation of any associated requirements that may affect this Project-Specific WQMP.

Section B: Optimize Site Utilization (LID Principles)

Review of the information collected in Section 'A' will aid in identifying the principal constraints on site design and selection of LID BMPs as well as opportunities to reduce imperviousness and incorporate LID Principles into the site and landscape design. For example, constraints might include impermeable soils, high groundwater, groundwater pollution or contaminated soils, steep slopes, geotechnical instability, high-intensity land use, heavy pedestrian or vehicular traffic, utility locations or safety concerns. Opportunities might include existing natural areas, low areas, oddly configured or otherwise unbuildable parcels, easements and landscape amenities including open space and buffers (which can double as locations for bioretention BMPs), and differences in elevation (which can provide hydraulic head). Prepare a brief narrative for each of the site optimization strategies described below. This narrative will help you as you proceed with your LID design and explain your design decisions to others.

The 2010 Santa Ana MS4 Permit further requires that LID Retention BMPs (Infiltration Only or Harvest and Use) be used unless it can be shown that those BMPs are infeasible. Therefore, it is important that your narrative identify and justify if there are any constraints that would prevent the use of those categories of LID BMPs. Similarly, you should also note opportunities that exist which will be utilized during project design. Upon completion of identifying Constraints and Opportunities, include these on your WQMP Site plan in Appendix 1.

Site Optimization

The following questions are based upon Section 3.2 of the WQMP Guidance Document. Review of the WQMP Guidance Document will help you determine how best to optimize your site and subsequently identify opportunities and/or constraints, and document compliance.

Did you identify and preserve existing drainage patterns? If so, how? If not, why?

- *There are no creeks, wetlands, or riparian habitats nearby.*
- *Existing drainage patterns flow easterly. Proposed condition drainage patterns mimic pre-development conditions.*

Did you identify and protect existing vegetation? If so, how? If not, why?

- *Not applicable, there are no sensitive areas.*
- *No applicable, there are no existing trees to preserve.*

Did you identify and preserve natural infiltration capacity? If so, how? If not, why?

- *Per the infiltration report, the two infiltration tests performed at the project site resulted in 0.0 inches per hour. Due to the poor infiltration characteristics of the on-site native soils at the tested depths, infiltration is not recommended; therefore, the project proposes to use an underground detention system and proprietary biotreatment unit to treat runoff produced by the 85th percentile storm rainfall depth.*

Did you identify and minimize impervious area? If so, how? If not, why?

- *Impervious area on the site has been minimized to City standards.*
- *Due to the nature of the project site (large trucks), substitution of pavement for landscaping is not feasible. The project does not propose overflow parking where substitution of pavement for*

landscaping would be optimal. Landscaping has been provided wherever applicable and to the maximum extent practicable.

- *The entire Design Capture Volume (DCV) is handled by the proposed underground detention system and proprietary biotreatment unit. Permeable pavement is not needed to meet the DCV.*

Did you identify and disperse runoff to adjacent pervious areas? If so, how? If not, why?

- *Roof runoff is directed to the underground detention system and proprietary biotreatment unit for treatment.*
- *The site is not on a hillside.*
- *All stormwater runoff will be piped or sheet flow into the underground detention system and proprietary biotreatment unit; therefore, curb-cuts into landscaped areas are not utilized.*

Section C: Delineate Drainage Management Areas (DMAs)

Utilizing the procedure in Section 3.3 of the WQMP Guidance Document which discusses the methods of delineating and mapping your project site into individual DMAs, complete Table C.1 below to appropriately categorize the types of classification (e.g., Type A, Type B, etc.) per DMA for your project site. Upon completion of this table, this information will then be used to populate and tabulate the corresponding tables for their respective DMA classifications.

Table C.1 DMA Classifications

DMA Name or ID	Surface Type(s) ¹	Area (Sq. Ft.)	Area (Acres)	DMA Type
A-1	Roofs/Conc/Asphalt	114,563	2.63	Type D
B-2	Ornamental Landscaping	4,356	0.10	Type A

¹Reference Table 2-1 in the WQMP Guidance Document to populate this column.

DMA B-2 consists of landscape areas that drain offsite.

Table C.2 Type 'A', Self-Treating Areas

DMA Name or ID	Area (Sq. Ft.)	Stabilization Type	Irrigation Type (if any)
B-2	4,356	California Native Vegetation	Timed Sprinklers

Table C.3 Type 'B', Self-Retaining Areas

Self-Retaining Area				Type 'C' DMAs that are draining to the Self-Retaining Area		
DMA Name/ ID	Post-project surface type	Area (square feet) [A]	Storm Depth (inches) [B]	DMA Name / ID	[C] from Table C.4 [C]	Required Retention Depth (inches) [D]
n/a	n/a	n/a	n/a	n/a	n/a	n/a

$$[D] = [B] + \frac{[B] \cdot [C]}{[A]}$$

Table C.4 Type 'C', Areas that Drain to Self-Retaining Areas

DMA					Receiving Self-Retaining DMA		
DMA Name/ ID	Area (square feet)	Post-project surface type	Runoff factor	Product	DMA name /ID	Area (square feet)	Ratio
	[A]		[B]	[C] = [A] x [B]		[D]	[C]/[D]
n/a	n/a	n/a	n/a	n/a	n/a	n/a	n/a

Table C.5 Type 'D', Areas Draining to BMPs

DMA Name or ID	BMP Name or ID
A-1	StormTech MC-3500 Chambers & Modular Wetlands System (STC-A & MWS-A)

Note: More than one drainage management area can drain to a single LID BMP, however, one drainage management area may not drain to more than one BMP.

Section D: Implement LID BMPs

D.1 Infiltration Applicability

Is there an approved downstream ‘Highest and Best Use’ for stormwater runoff (see discussion in Chapter 2.4.4 of the WQMP Guidance Document for further details)? Y N

If yes has been checked, Infiltration BMPs shall not be used for the site. If no, continue working through this section to implement your LID BMPs. It is recommended that you contact your Co-Permittee to verify whether or not your project discharges to an approved downstream ‘Highest and Best Use’ feature.

Geotechnical Report

A Geotechnical Report or Phase I Environmental Site Assessment may be required by the Copermitttee to confirm present and past site characteristics that may affect the use of Infiltration BMPs. In addition, the Co-Permittee, at their discretion, may not require a geotechnical report for small projects as described in Chapter 2 of the WQMP Guidance Document. If a geotechnical report has been prepared, include it in Appendix 3. In addition, if a Phase I Environmental Site Assessment has been prepared, include it in Appendix 4.

Is this project classified as a small project consistent with the requirements of Chapter 2 of the WQMP Guidance Document? Y N

Infiltration Feasibility

Table D.1 below is meant to provide a simple means of assessing which DMAs on your site support Infiltration BMPs and is discussed in the WQMP Guidance Document in Chapter 2.4.5. Check the appropriate box for each question and then list affected DMAs as applicable. If additional space is needed, add a row below the corresponding answer.

Table D.1 Infiltration Feasibility

Does the project site...	YES	NO
...have any DMAs with a seasonal high groundwater mark shallower than 10 feet? If Yes, list affected DMAs:		X
...have any DMAs located within 100 feet of a water supply well? If Yes, list affected DMAs:		X
...have any areas identified by the geotechnical report as posing a public safety risk where infiltration of stormwater could have a negative impact? If Yes, list affected DMAs:		X
...have measured in-situ infiltration rates of less than 1.6 inches / hour? If Yes, list affected DMAs: Per the infiltration report, the two infiltration tests performed at the project site resulted in 0.0 inches per hour. Due to the poor infiltration characteristics of the on-site native soils at the tested depths, infiltration is not recommended; therefore, the project proposes to use an underground detention system and proprietary biotreatment unit to treat runoff produced by the 85th percentile storm rainfall depth.	X	
...have significant cut and/or fill conditions that would preclude in-situ testing of infiltration rates at the final infiltration surface? If Yes, list affected DMAs:		X
...geotechnical report identify other site-specific factors that would preclude effective and safe infiltration? Describe here:		X

If you answered “Yes” to any of the questions above for any DMA, Infiltration BMPs should not be used for those DMAs and you should proceed to the assessment for Harvest and Use below.

D.2 Harvest and Use Assessment

Please check what applies:

- Reclaimed water will be used for the non-potable water demands for the project.
- Downstream water rights may be impacted by Harvest and Use as approved by the Regional Board (verify with the Copermittee).
- The Design Capture Volume will be addressed using Infiltration Only BMPs. In such a case, Harvest and Use BMPs are still encouraged, but it would not be required if the Design Capture Volume will be infiltrated or evapotranspired.
- None of the above

If any of the above boxes have been checked, Harvest and Use BMPs need not be assessed for the site. If neither of the above criteria applies, follow the steps below to assess the feasibility of irrigation use, toilet use and other non-potable uses (e.g., industrial use).

Irrigation Use Feasibility

Complete the following steps to determine the feasibility of harvesting stormwater runoff for Irrigation Use BMPs on your site:

Step 1: Identify the total area of irrigated landscape on the site, and the type of landscaping used.

Total Area of Irrigated Landscape: 0.10 acres

Type of Landscaping (Conservation Design or Active Turf): Conservative Design

Step 2: Identify the planned total of all impervious areas on the proposed project from which runoff might be feasibly captured and stored for irrigation use. Depending on the configuration of buildings and other impervious areas on the site, you may consider the site as a whole, or parts of the site, to evaluate reasonable scenarios for capturing and storing runoff and directing the stored runoff to the potential use(s) identified in Step 1 above.

Total Area of Impervious Surfaces: 2.63 acres

Step 3: Cross reference the Design Storm depth for the project site (see Exhibit A of the WQMP Guidance Document) with the left column of Table 2-3 in Chapter 2 to determine the minimum area of Effective Irrigated Area per Tributary Impervious Area (EIATIA).

Enter your EIATIA factor: 1.05

Step 4: Multiply the unit value obtained from Step 3 by the total of impervious areas from Step 2 to develop the minimum irrigated area that would be required.

Minimum required irrigated area: 2.76 acres

Step 5: Determine if harvesting stormwater runoff for irrigation use is feasible for the project by comparing the total area of irrigated landscape (Step 1) to the minimum required irrigated area (Step 4).

Minimum required irrigated area (Step 4)	Available Irrigated Landscape (Step 1)
2.76 acres	0.10 acres

Toilet Use Feasibility

Complete the following steps to determine the feasibility of harvesting stormwater runoff for toilet flushing uses on your site:

Step 1: Identify the projected total number of daily toilet users during the wet season, and account for any periodic shut downs or other lapses in occupancy:

Projected Number of Daily Toilet Users: N/A (project consists of a trailer yard)

Project Type: N/A

Step 2: Identify the planned total of all impervious areas on the proposed project from which runoff might be feasibly captured and stored for toilet use. Depending on the configuration of buildings and other impervious areas on the site, you may consider the site as a whole, or parts of the site, to evaluate reasonable scenarios for capturing and storing runoff and directing the stored runoff to the potential use(s) identified in Step 1 above.

Total Area of Impervious Surfaces: N/A

Step 3: Enter the Design Storm depth for the project site (see Exhibit A) into the left column of Table 2-2 in Chapter 2 to determine the minimum number of toilet users per tributary impervious acre (TUTIA).

Enter your TUTIA factor: N/A

Step 4: Multiply the unit value obtained from Step 3 by the total of impervious areas from Step 2 to develop the minimum number of toilet users that would be required.

Minimum number of toilet users: N/A

Step 5: Determine if harvesting stormwater runoff for toilet flushing use is feasible for the project by comparing the Number of Daily Toilet Users (Step 1) to the minimum required number of toilet users (Step 4).

Minimum required Toilet Users (Step 4)	Projected number of toilet users (Step 1)
N/A	N/A

Other Non-Potable Use Feasibility

Are there other non-potable uses for stormwater runoff on the site (e.g. industrial use)? See Chapter 2 of the Guidance for further information. If yes, describe below. If no, write N/A.

N/A

Step 1: Identify the projected average daily non-potable demand, in gallons per day, during the wet season and accounting for any periodic shut downs or other lapses in occupancy or operation.

Average Daily Demand: N/A

Step 2: Identify the planned total of all impervious areas on the proposed project from which runoff might be feasibly captured and stored for the identified non-potable use. Depending on the configuration of buildings and other impervious areas on the site, you may consider the site as a whole, or parts of the site, to evaluate reasonable scenarios for capturing and storing runoff and directing the stored runoff to the potential use(s) identified in Step 1 above.

Total Area of Impervious Surfaces: N/A

Step 3: Enter the Design Storm depth for the project site (see Exhibit A) into the left column of Table 2-3 in Chapter 2 to determine the minimum demand for non-potable uses per tributary impervious acre.

Enter the factor from Table 2-3: N/A

Step 4: Multiply the unit value obtained from Step 4 by the total of impervious areas from Step 3 to develop the minimum number of gallons per day of non-potable use that would be required.

Minimum required use: N/A

Step 5: Determine if harvesting stormwater runoff for other non-potable use is feasible for the project by comparing the Number of Daily Toilet Users (Step 1) to the minimum required number of toilet users (Step 4).

Minimum required non-potable use (Step 4)	Projected average daily use (Step 1)
N/A	N/A

If Irrigation, Toilet and Other Use feasibility anticipated demands are less than the applicable minimum values, Harvest and Use BMPs are not required and you should proceed to utilize LID Bioretention and Biotreatment, unless a site-specific analysis has been completed that demonstrates technical infeasibility as noted in D.3 below.

D.3 Bioretention and Biotreatment Assessment

Other LID Bioretention and Biotreatment BMPs as described in Chapter 2.4.7 of the WQMP Guidance Document are feasible on nearly all development sites with sufficient advance planning.

Select one of the following:

- LID Bioretention/Biotreatment BMPs will be used for some or all DMAs of the project as noted below in Section D.4 (note the requirements of Section 3.4.2 in the WQMP Guidance Document).
- A site-specific analysis demonstrating the technical infeasibility of all LID BMPs has been performed and is included in Appendix 5. If you plan to submit an analysis demonstrating the technical infeasibility of LID BMPs, request a pre-submittal meeting with the Copermitttee to discuss this option. Proceed to Section E to document your alternative compliance measures.

D.4 Feasibility Assessment Summaries

From the Infiltration, Harvest and Use, Bioretention and Biotreatment Sections above, complete Table D.2 below to summarize which LID BMPs are technically feasible, and which are not, based upon the established hierarchy.

Table D.2 LID Prioritization Summary Matrix

DMA Name/ID	LID BMP Hierarchy				Alternative Compliance (Modular Wetlands System)
	1. Infiltration	2. Harvest and use	3. Bioretention	4. Biotreatment	
A-1	<input type="checkbox"/>	<input type="checkbox"/>	<input type="checkbox"/>	<input type="checkbox"/>	<input checked="" type="checkbox"/>

For those DMAs where LID BMPs are not feasible, provide a brief narrative below summarizing why they are not feasible, include your technical infeasibility criteria in Appendix 5, and proceed to Section E below to document Alternative Compliance measures for those DMAs. Recall that each proposed DMA must pass through the LID BMP hierarchy before alternative compliance measures may be considered.

D.5 LID BMP Sizing

Each LID BMP must be designed to ensure that the Design Capture Volume will be addressed by the selected BMPs. First, calculate the Design Capture Volume for each LID BMP using the V_{BMP} worksheet in Appendix F of the LID BMP Design Handbook. Second, design the LID BMP to meet the required V_{BMP} using a method approved by the Copermittee. Utilize the worksheets found in the LID BMP Design Handbook or consult with your Copermittee to assist you in correctly sizing your LID BMPs. Complete Table D.3 below to document the Design Capture Volume and the Proposed Volume for each LID BMP. Provide the completed design procedure sheets for each LID BMP in Appendix 6. You may add additional rows to the table below as needed.

Table D.3 DCV Calculations for LID BMPs

DMA Type/ID	DMA Area (square feet)	Post-Project Surface Type	Effective Impervious Fraction, I_f	DMA Runoff Factor	DMA Areas x Runoff Factor	StormTech MC-3500 Chambers & Modular Wetlands System (STC-A & MWS-A)		
						Design Storm Depth (in)	Design Capture Volume, V_{BMP} (cubic feet)	Proposed Volume on Plans (cubic feet)*
	[A]		[B]	[C]	[A] x [C]			
A-1	114,563	Roofs/Conc/Asphalt	1.00	0.89	102,190.0	0.611	5203.2	5,372
	114,563				102,190	0.611	5,203	5,372

[B], [C] is obtained as described in Section 2.3.1 of the WQMP Guidance Document

[E] is obtained from Exhibit A in the WQMP Guidance Document

[G] is obtained from a design procedure sheet, such as in LID BMP Design Handbook and placed in Appendix 6

*Proposed volume = Installed Storage Volume + MWS Linear Static Capacity

$$= 81 \text{ cu-ft} + 5,291 \text{ cu-ft} = 5,372 \text{ cu-ft}$$

Section E: Alternative Compliance (LID Waiver Program)

LID BMPs are expected to be feasible on virtually all projects. Where LID BMPs have been demonstrated to be infeasible as documented in Section D, other Treatment Control BMPs must be used (subject to LID waiver approval by the Copermittee). Check one of the following Boxes:

LID Principles and LID BMPs have been incorporated into the site design to fully address all Drainage Management Areas. No alternative compliance measures are required for this project and thus this Section is not required to be completed.

- Or -

The following Drainage Management Areas are unable to be addressed using LID BMPs. A site-specific analysis demonstrating technical infeasibility of LID BMPs has been approved by the Co-Permittee and included in Appendix 5. Additionally, no downstream regional and/or sub-regional LID BMPs exist or are available for use by the project. The following alternative compliance measures on the following pages are being implemented to ensure that any pollutant loads expected to be discharged by not incorporating LID BMPs, are fully mitigated.

E.1 Identify Pollutants of Concern

Utilizing Table A.1 from Section A above which noted your project's receiving waters and their associated EPA approved 303(d) listed impairments, cross reference this information with that of your selected Priority Development Project Category in Table E.1 below. If the identified General Pollutant Categories are the same as those listed for your receiving waters, then these will be your Pollutants of Concern and the appropriate box or boxes will be checked on the last row. The purpose of this is to document compliance and to help you appropriately plan for mitigating your Pollutants of Concern in lieu of implementing LID BMPs.

Table E.1 Potential Pollutants by Land Use Type

Priority Development Project Categories and/or Project Features (check those that apply)	General Pollutant Categories							
	Bacterial Indicators	Metals	Nutrients	Pesticides	Toxic Organic Compounds	Sediments	Trash & Debris	Oil & Grease
<input type="checkbox"/> Detached Residential Development	P	N	P	P	N	P	P	P
<input type="checkbox"/> Attached Residential Development	P	N	P	P	N	P	P	P ⁽²⁾
<input checked="" type="checkbox"/> Commercial/Industrial Development	P ⁽³⁾	P	P ⁽¹⁾	P ⁽¹⁾	P ⁽⁵⁾	P ⁽¹⁾	P	P
<input type="checkbox"/> Automotive Repair Shops	N	P	N	N	P ^(4, 5)	N	P	P
<input type="checkbox"/> Restaurants (>5,000 ft ²)	P	N	N	N	N	N	P	P
<input type="checkbox"/> Hillside Development (>5,000 ft ²)	P	N	P	P	N	P	P	P
<input checked="" type="checkbox"/> Parking Lots (>5,000 ft ²)	P ⁽⁶⁾	P	P ⁽¹⁾	P ⁽¹⁾	P ⁽⁴⁾	P ⁽¹⁾	P	P
<input type="checkbox"/> Retail Gasoline Outlets	N	P	N	N	P	N	P	P
Project Priority Pollutant(s) of Concern	<input type="checkbox"/>	<input checked="" type="checkbox"/>	<input type="checkbox"/>	<input type="checkbox"/>	<input type="checkbox"/>	<input type="checkbox"/>	<input checked="" type="checkbox"/>	<input checked="" type="checkbox"/>

P = Potential

N = Not Potential

⁽¹⁾ A potential Pollutant if non-native landscaping exists or is proposed onsite; otherwise not expected

⁽²⁾ A potential Pollutant if the project includes uncovered parking areas; otherwise not expected

⁽³⁾ A potential Pollutant is land use involving animal waste

⁽⁴⁾ Specifically petroleum hydrocarbons

⁽⁵⁾ Specifically solvents

⁽⁶⁾ Bacterial indicators are routinely detected in pavement runoff

E.2 Stormwater Credits

Projects that cannot implement LID BMPs but nevertheless implement smart growth principles are potentially eligible for Stormwater Credits. Utilize Table 3-8 within the WQMP Guidance Document to identify your Project Category and its associated Water Quality Credit. If not applicable, write N/A.

Table E.2 Water Quality Credits

Qualifying Project Categories	Credit Percentage ²
N/A	
<i>Total Credit Percentage¹</i>	

¹Cannot Exceed 50%

²Obtain corresponding data from Table 3-8 in the WQMP Guidance Document

E.3 Sizing Criteria

After you appropriately considered Stormwater Credits for your project, utilize Table E.3 below to appropriately size them to the DCV, or Design Flow Rate, as applicable. Please reference Chapter 3.5.2 of the WQMP Guidance Document for further information.

Table E.3 Treatment Control BMP Sizing

DMA Type/ ID	DMA Area (square feet)	Post- Project Surface Type	Effective Imp Fraction, I_f	DMA Runoff Factor	DMA Area x Runoff Factor						
	[A]		[B]	[C]	[A] x [C]						
N/A	N/A	N/A	N/A	N/A	N/A	Design Storm Depth (in)	Minimum Design Capture Volume (cubic feet)	Total Storm Water Credit % Reduction	Proposed Volume or Flow on Plans (cubic feet or cfs)		

[B], [C] is obtained as described in Section 2.3.1 from the WQMP Guidance Document

[E] is obtained from Exhibit A in the WQMP Guidance Document

[G] is for Flow-Based Treatment Control BMPs [G] = 43,560, for Volume-Based Control Treatment BMPs, [G] = 12

[H] is from the Total Credit Percentage as Calculated from Table E.2 above

[I] as obtained from a design procedure sheet from the BMP manufacturer and should be included in Appendix 6

E.4 Treatment Control BMP Selection

Treatment Control BMPs typically provide proprietary treatment mechanisms to treat potential pollutants in runoff, but do not sustain significant biological processes. Treatment Control BMPs must have a removal efficiency of a medium or high effectiveness as quantified below:

- **High:** equal to or greater than 80% removal efficiency
- **Medium:** between 40% and 80% removal efficiency

Such removal efficiency documentation (e.g., studies, reports, etc.) as further discussed in Chapter 3.5.2 of the WQMP Guidance Document, must be included in Appendix 6. In addition, ensure that proposed Treatment Control BMPs are properly identified on the WQMP Site Plan in Appendix 1.

Table E.4 Treatment Control BMP Selection

Selected Treatment Control BMP Name or ID ¹	Priority Pollutant(s) of Concern to Mitigate ²	Removal Efficiency Percentage ³
Modular Wetlands System	Metals	38%-69%
Modular Wetlands System	Trash & Debris/TSS	85%
Modular Wetlands System	Oil & Grease	95%

¹ Treatment Control BMPs must not be constructed within Receiving Waters. In addition, a proposed Treatment Control BMP may be listed more than once if they possess more than one qualifying pollutant removal efficiency.

² Cross Reference Table E.1 above to populate this column.

³ As documented in a Co-Permittee Approved Study and provided in Appendix 6.

Section F: Hydromodification

F.1 Hydrologic Conditions of Concern (HCOC) Analysis

Once you have determined that the LID design is adequate to address water quality requirements, you will need to assess if the proposed LID Design may still create a HCOC. Review Chapters 2 and 3 (including Figure 3-7) of the WQMP Guidance Document to determine if your project must mitigate for Hydromodification impacts. If your project meets one of the following criteria which will be indicated by the check boxes below, you do not need to address Hydromodification at this time. However, if the project does not qualify for Exemptions 1, 2 or 3, then additional measures must be added to the design to comply with HCOC criteria. This is discussed in further detail below in Section F.2.

HCOC EXEMPTION 1: The Priority Development Project disturbs less than one acre. The Copermitttee has the discretion to require a Project-Specific WQMP to address HCOCs on projects less than one acre on a case by case basis. The disturbed area calculation should include all disturbances associated with larger common plans of development.

Does the project qualify for this HCOC Exemption? Y N

If Yes, HCOC criteria do not apply.

HCOC EXEMPTION 2: The volume and time of concentration¹ of storm water runoff for the post-development condition is not significantly different from the pre-development condition for a 2-year return frequency storm (a difference of 5% or less is considered insignificant) using one of the following methods to calculate:

- Riverside County Hydrology Manual
- Technical Release 55 (TR-55): Urban Hydrology for Small Watersheds (NRCS 1986), or derivatives thereof, such as the Santa Barbara Urban Hydrograph Method
- Other methods acceptable to the Co-Permittee

Does the project qualify for this HCOC Exemption? Y N

If yes, report results in Table F.1 below and provide your substantiated hydrologic analysis in Appendix 7.

Table F.1 Hydrologic Conditions of Concern Summary

	2 year – 24 hour		
	Pre-condition	Post-condition	% Difference
Time of Concentration (min)	N/A	N/A	N/A
Volume (Cubic Feet)	N/A	N/A	N/A

¹ Time of concentration is defined as the time after the beginning of the rainfall when all portions of the drainage basin are contributing to flow at the outlet.

HCOC EXEMPTION 3: All downstream conveyance channels to an adequate sump (for example, Prado Dam, Lake Elsinore, Canyon Lake, Santa Ana River, or other lake, reservoir or naturally erosion resistant feature) that will receive runoff from the project are engineered and regularly maintained to ensure design flow capacity; no sensitive stream habitat areas will be adversely affected; or are not identified on the Co-Permittees Hydromodification Sensitivity Maps.

Does the project qualify for this HCOC Exemption? Y N

If Yes, HCOC criteria do not apply and note below which adequate sump applies to this HCOC qualifier:

F.2 HCOC Mitigation

As an alternative to the HCOC Exemption Criteria above, HCOC criteria is considered mitigated if the project meets one of the following conditions, as indicated:

- a. Additional LID BMPS are implemented onsite or offsite to mitigate potential erosion or habitat impacts as a result of HCOCs. This can be conducted by an evaluation of site-specific conditions utilizing accepted professional methodologies published by entities such as the California Stormwater Quality Association (CASQA), the Southern California Coastal Water Research Project (SCCRWP), or other Co-Permittee approved methodologies for site-specific HCOC analysis.
- b. The project is developed consistent with an approved Watershed Action Plan that addresses HCOC in Receiving Waters.
- c. Mimicking the pre-development hydrograph with the post-development hydrograph, for a 2-year return frequency storm. Generally, the hydrologic conditions of concern are not significant, if the post-development hydrograph is no more than 10% greater than pre-development hydrograph. In cases where excess volume cannot be infiltrated or captured and reused, discharge from the site must be limited to a flow rate no greater than 110% of the pre-development 2-year peak flow.
- d. None of the above.

All pertinent documentation used in analysis of the items a, b or c can be found in Appendix 7.

The project site is located within the exempted HCOC area, as presented in the April 20, 2017 approved WAP/HCOC document. Refer to HCOC map provided in Appendix 7.

Section G: Source Control BMPs

Source control BMPs include permanent, structural features that may be required in your project plans — such as roofs over and berms around trash and recycling areas — and Operational BMPs, such as regular sweeping and “housekeeping”, that must be implemented by the site’s occupant or user. The MEP standard typically requires both types of BMPs. In general, Operational BMPs cannot be substituted for a feasible and effective permanent BMP. Using the Pollutant Sources/Source Control Checklist in Appendix 8, review the following procedure to specify Source Control BMPs for your site:

1. **Identify Pollutant Sources:** Review Column 1 in the Pollutant Sources/Source Control Checklist. Check off the potential sources of Pollutants that apply to your site.
2. **Note Locations on Project-Specific WQMP Exhibit:** Note the corresponding requirements listed in Column 2 of the Pollutant Sources/Source Control Checklist. Show the location of each Pollutant source and each permanent Source Control BMP in your Project-Specific WQMP Exhibit located in Appendix 1.
3. **Prepare a Table and Narrative:** Check off the corresponding requirements listed in Column 3 in the Pollutant Sources/Source Control Checklist. In the left column of Table G.1 below, list each potential source of runoff Pollutants on your site (from those that you checked in the Pollutant Sources/Source Control Checklist). In the middle column, list the corresponding permanent, Structural Source Control BMPs (from Columns 2 and 3 of the Pollutant Sources/Source Control Checklist) used to prevent Pollutants from entering runoff. **Add additional narrative** in this column that explains any special features, materials or methods of construction that will be used to implement these permanent, Structural Source Control BMPs.
4. **Identify Operational Source Control BMPs:** To complete your table, refer once again to the Pollutant Sources/Source Control Checklist. List in the right column of your table the Operational BMPs that should be implemented as long as the anticipated activities continue at the site. Copermittee stormwater ordinances require that applicable Source Control BMPs be implemented; the same BMPs may also be required as a condition of a use permit or other revocable Discretionary Approval for use of the site.

Table G.1 Permanent and Operational Source Control Measures

Potential Sources of Runoff pollutants	Permanent Structural Source Control BMPs	Operational Source Control BMPs
<p>A. On-site storm drain inlets</p>	<ul style="list-style-type: none"> • Mark all inlets with the words “Only Rain Down the Storm Drain” or similar. • Catch Basin Markers may be available from the Riverside County Flood Control and Water Conservation District, call 951.955.1200 to verify. • Inlets to be equipped with filter inserts. 	<ul style="list-style-type: none"> • Maintain and repaint (or replace) inlet stencils annually. • Filter inserts shall be inspected four times per year or following any rain event that would potentially accumulate a large amount of debris in the system. Replace boom twice per year, at a minimum. • Provide stormwater pollution prevention information to new site owners, lessees, or operators upon occupancy and annually thereafter. • See CASQA fact sheet SC-44 for “Drainage System Maintenance,” included in Appendix 10 of this document. • Include the following lease agreements: “Tenant shall not allow anyone to discharge anything to storm drain or to store or deposit materials so as to create a potential discharge to storm drains.” • See Appendix 10 for “Stormwater Pollution Solution Guide” brochure by EPA.
<p>D2. Landscape / Outdoor Pesticide Use</p>	<ul style="list-style-type: none"> • Landscape plans will minimize irrigation and runoff, to promote surface infiltration where appropriate, and to minimize the use of fertilizers and pesticides that can contribute to stormwater pollution. • Pest-resistant plans will be used adjacent to hardscape. • The landscape plans will consider plants appropriate to the site soils, slopes, climate, sun, wind, rain, land use, air movement, ecological consistency, and plant interactions. 	<ul style="list-style-type: none"> • Maintenance shall be conducted by a landscape contractor on a weekly basis to verify that the irrigation system is functioning properly and to repair as needed. Landscape contractor will also verify that there are no leaks or run-off from landscaped areas. Adjust irrigation heads and system run times as necessary to prevent overwatering of vegetation, overspray or run-off from landscaped areas to ensure the health and aesthetic quality of the landscape. Mowing and trimming waste shall be properly removed from the site and herbicides, pesticides and fertilizers shall be properly applied to prevent storm drainage contamination. • Maintain landscaping only using minimum pesticides, when needed. • See Appendix 10 for “Landscape and Gardening” brochure by RCFlood. • Provide Integrated Pest Management (IPM) information to new owners, lessees and operators upon occupancy and annually thereafter. IPM is an effective and environmentally sensitive approach to pest management.
<p>O. Miscellaneous Drain or Wash Water or Other Sources</p>	<ul style="list-style-type: none"> • Drainage sumps on-site shall feature a sediment sump to reduce the quantity of sediment in pumped water. 	

<p>P. Plazas, sidewalks, and parking lots</p>		<ul style="list-style-type: none">• Sweep plazas, sidewalks, and parking lots monthly to prevent accumulation of litter and debris. Collect debris from pressure washing to prevent entry into the storm drain system. Collect washwater containing any cleaning agent or degreaser and discharge to the sanitary sewer not to a storm drain.
---	--	---

Section H: Construction Plan Checklist

Populate Table H.1 below to assist the plan checker in an expeditious review of your project. The first two columns will contain information that was prepared in previous steps, while the last column will be populated with the corresponding plan sheets. This table is to be completed with the submittal of your final Project-Specific WQMP.

Table H.1 Construction Plan Cross-reference

BMP No. or ID	BMP Identifier and Description	Corresponding Plan Sheet(s)	Latitude	Longitude
A	On-site storm drain inlets	Conceptual Grading Plan Sheets 1 and 3	---	---
B	Interior floor drains and elevator shaft sump pumps	N/A	---	---
D2	Landscape / Outdoor Pesticide Use	On-site Landscape Improvement Plans	---	---
G	Refuse Areas	N/A	---	---
H	Industrial processes	N/A	---	---
P	Plazas, sidewalks, and parking lots	Conceptual Grading Plan Sheets 1 and 3	---	---
MWS-A	Modular Wetlands System	Conceptual Grading Plan Sheets 1 and 3	33.855299	-117.246201
STC-A	Underground Detention	Conceptual Grading Plan Sheets 1 and 3	33.855166	-117.246029

Note that the updated table — or Construction Plan WQMP Checklist — is **only a reference tool** to facilitate an easy comparison of the construction plans to your Project-Specific WQMP. Co-Permittee staff can advise you regarding the process required to propose changes to the approved Project-Specific WQMP.

Section I: Operation, Maintenance and Funding

The Copermittee will periodically verify that Stormwater BMPs on your site are maintained and continue to operate as designed. To make this possible, your Copermittee will require that you include in Appendix 9 of this Project-Specific WQMP:

1. A means to finance and implement facility maintenance in perpetuity, including replacement cost.
2. Acceptance of responsibility for maintenance from the time the BMPs are constructed until responsibility for operation and maintenance is legally transferred. A warranty covering a period following construction may also be required.
3. An outline of general maintenance requirements for the Stormwater BMPs you have selected.
4. Figures delineating and designating pervious and impervious areas, location, and type of Stormwater BMP, and tables of pervious and impervious areas served by each facility. Geo-locating the BMPs using a coordinate system of latitude and longitude is recommended to help facilitate a future statewide database system.
5. A separate list and location of self-retaining areas or areas addressed by LID Principles that do not require specialized O&M or inspections but will require typical landscape maintenance as noted in Chapter 5, pages 85-86, in the WQMP Guidance. Include a brief description of typical landscape maintenance for these areas.

Your local Co-Permittee will also require that you prepare and submit a detailed Stormwater BMP Operation and Maintenance Plan that sets forth a maintenance schedule for each of the Stormwater BMPs built on your site. An agreement assigning responsibility for maintenance and providing for inspections and certification may also be required.

Details of these requirements and instructions for preparing a Stormwater BMP Operation and Maintenance Plan are in Chapter 5 of the WQMP Guidance Document.

Maintenance Mechanism: City of Perris: Covenant and Agreement
Water Quality Management Plan and Urban Runoff BMP Transfer, Access and Maintenance Agreement

Will the proposed BMPs be maintained by a Home Owners' Association (HOA) or Property Owners Association (POA)?

Y N

Include your Operation and Maintenance Plan and Maintenance Mechanism in Appendix 9. Additionally, include all pertinent forms of educational materials for those personnel that will be maintaining the proposed BMPs within this Project-Specific WQMP in Appendix 10.

This section will be completed and addressed at the time of the final WQMP Submittal

Appendix 1: Maps and Site Plans

Location Map, WQMP Site Plan and Receiving Waters Map



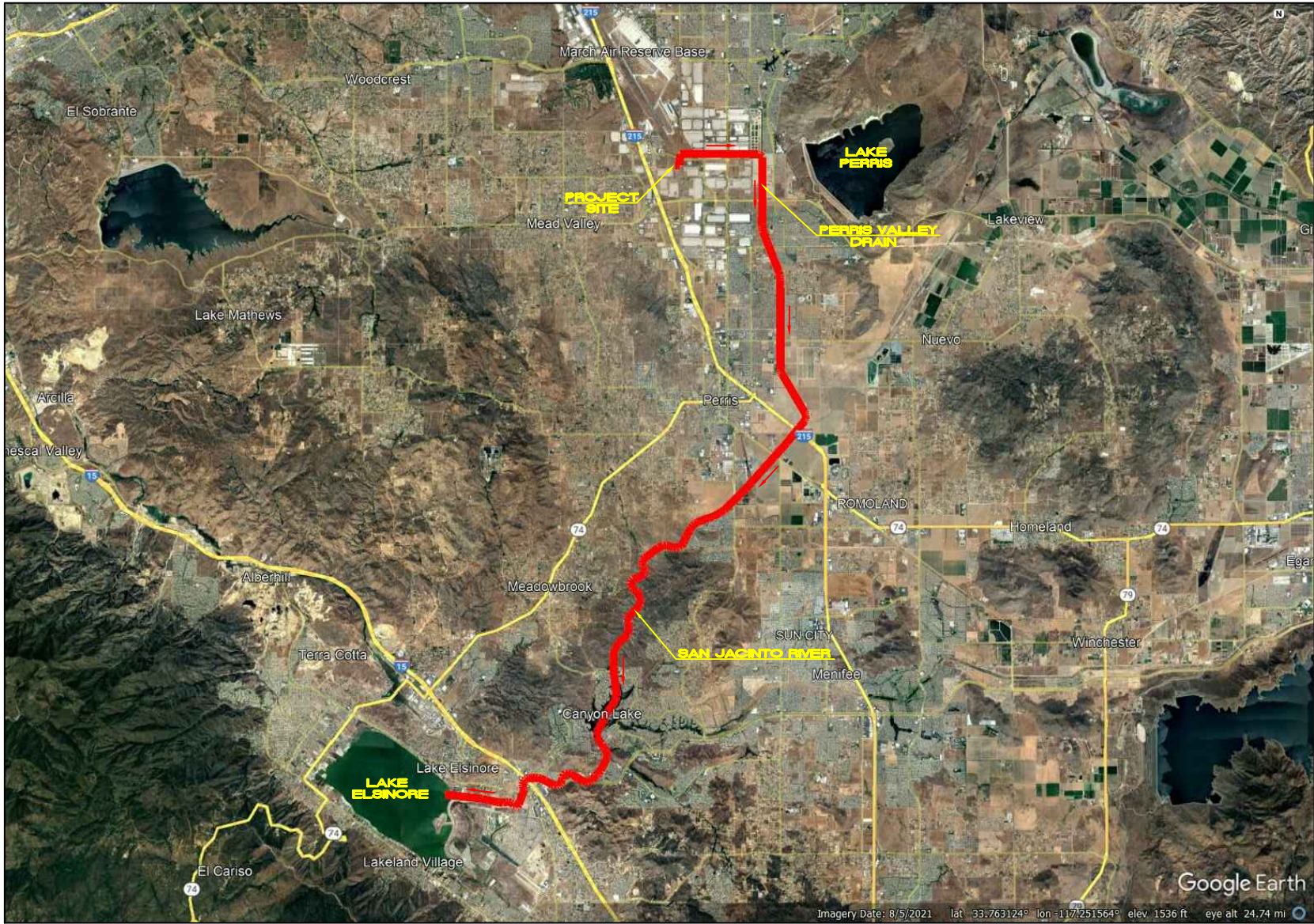

Last Update: 2/21/23
 O:\4100-4199\4130\4130VICMAP.dwg

TEI Thienes Engineering, Inc.
 CIVIL ENGINEERING • LAND SURVEYING
 14349 FIRESTONE BOULEVARD
 LA MIRADA, CALIFORNIA 90638
 PH.(714)521-4811 FAX(714)521-4173

"RECEIVING WATERS MAP"

FOR

**PERRIS TRAILER YARD
NANCE STREET, PERRIS**

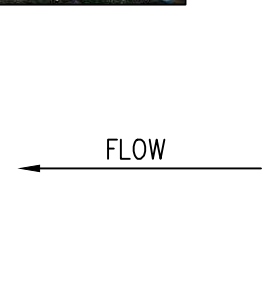

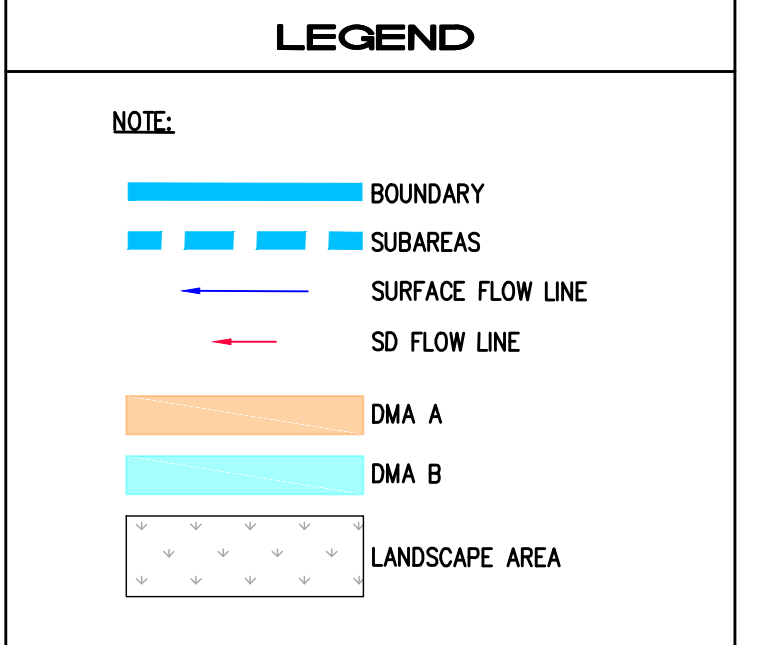
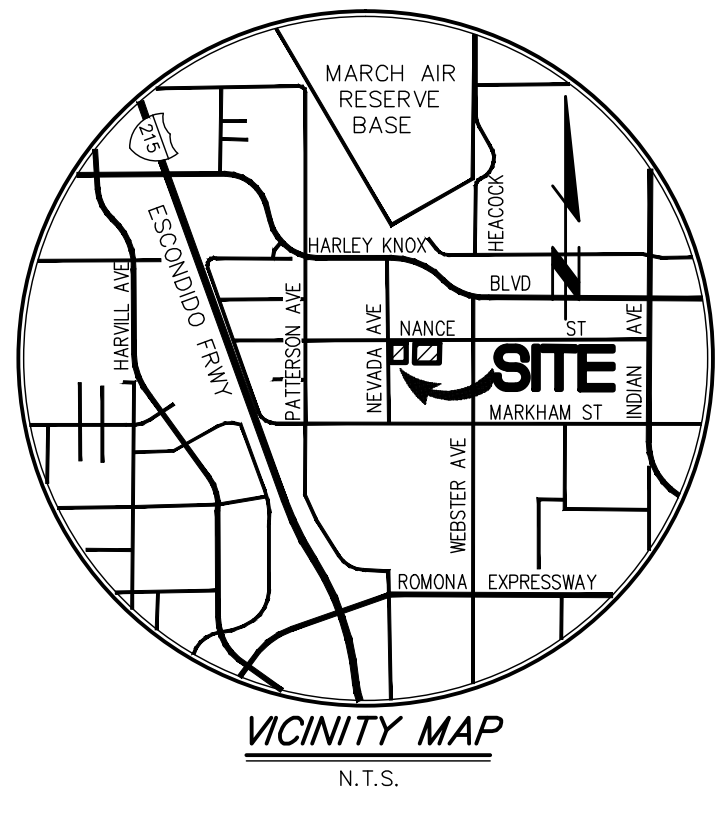
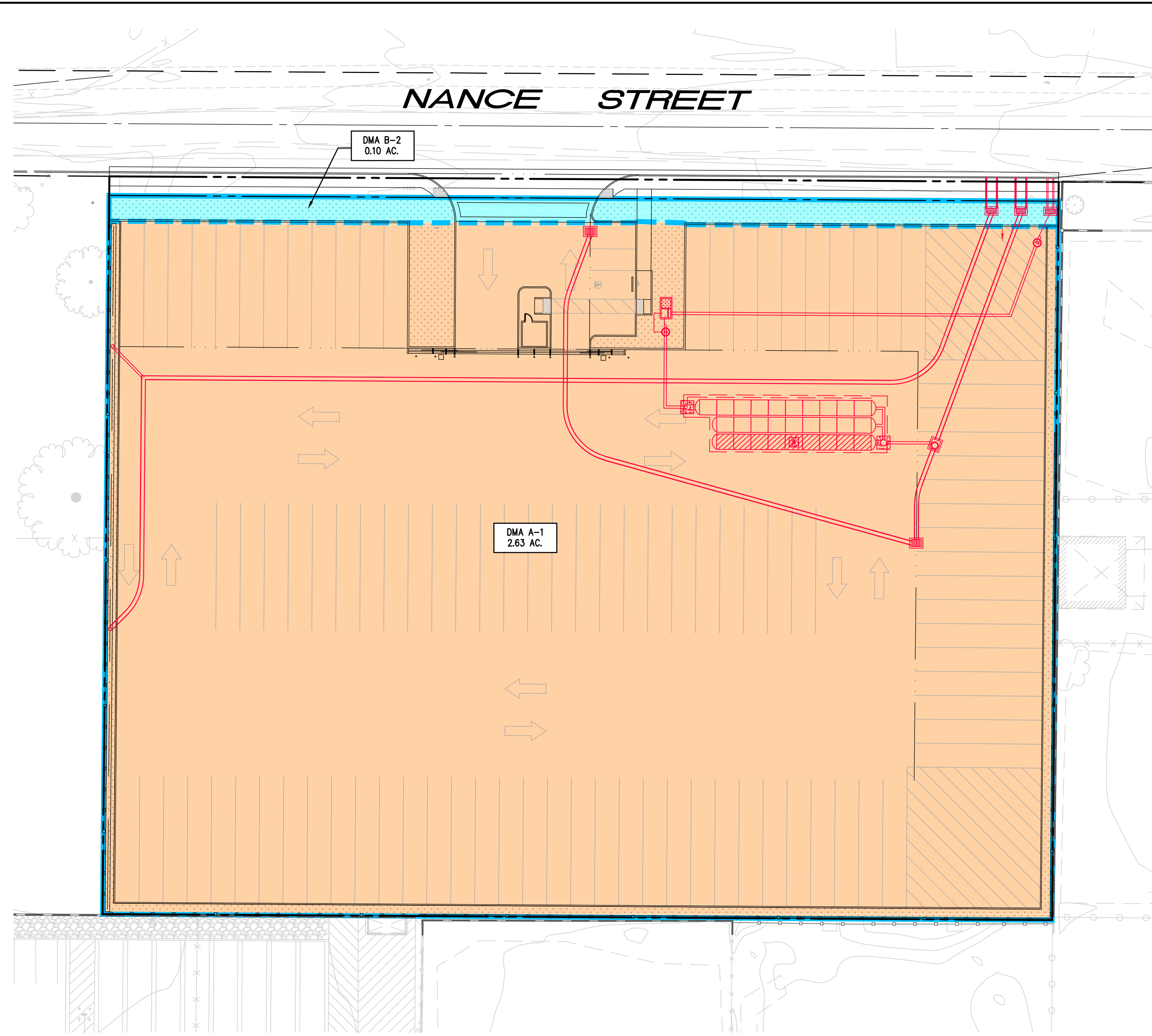

DMA Name or ID	Surface Type(s)	Area (Sq. Ft.)	Area (Acres)	DMA Type
A-1	Roofs/Conc/Asphalt	114,563	2.63	Type D
B-2	Ornamental Landscaping	4,356	0.10	Type A

DMA	AREA (ACRES)	DCV (CF)	MODULAR WETLANDS SYSTEM (MWS)		MC-3500 STORMTECH CHAMBERS			TOTAL VOLUME PROVIDED (CF)
			MWS MODEL	LINEAR STATIC CAPACITY (CF)	DETENTION REQUIRED (CF)	DETENTION PROVIDED (CF)	# OF CHAMBERS	
A	2.63	5,203	MWS-L-4-8	81	5,122	5,291	28	5,372
TOTAL	2.63	5,203		81	5,122	5,291	28	5,372

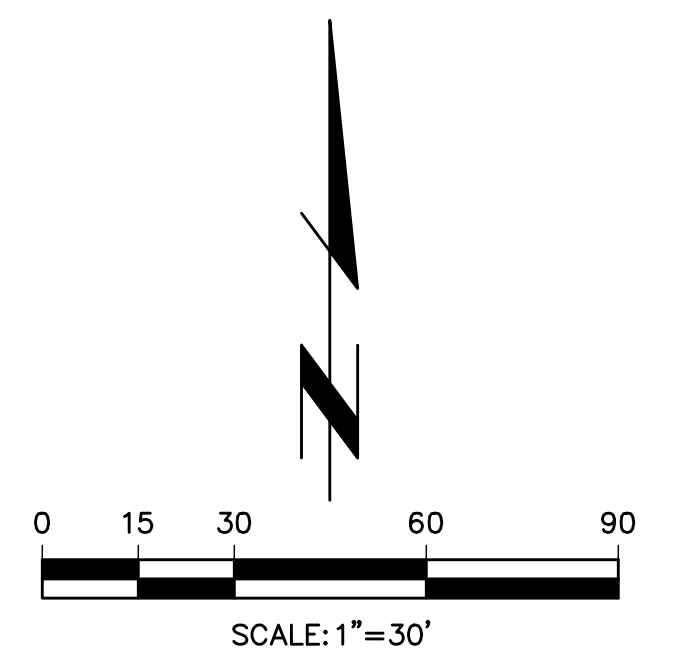

Last Update: 2/23/23
C:\4100-4199\4130\4130BMP\ITEMAP-EAST.dwg

CITY OF PERRIS
PUBLIC WORKS DEPARTMENT

**POST-CONSTRUCTION
BMP SITE MAP
DMA PLAN**

**PERRIS TRAILER YARD
NANCE STREET
P23-XXXX**

Designed by _____	Approved by _____	Date _____
Checked by _____		
Date _____		
Designed by _____	Public Works Director _____	R.C.E. _____
Date _____		
Checked by _____		
Date _____		

Sheet **1** of **1** Sheets

JN: 4130
LOT DATE: 02/23/2023

PREPARED FOR:
LAKE CREEK INDUSTRIAL, LLC
1302 BRITTANY CROSS RD.
SANTA ANA, CALIFORNIA 92705
PHONE: (949) 910-4616

PREPARED BY:
TEI Thienes Engineering, Inc.
CIVIL ENGINEERING • LAND SURVEYING
14349 TRESTLE BOULEVARD
LA MIRADA, CALIFORNIA 90638
PH: (714) 321-1811 FAX: (714) 321-4173

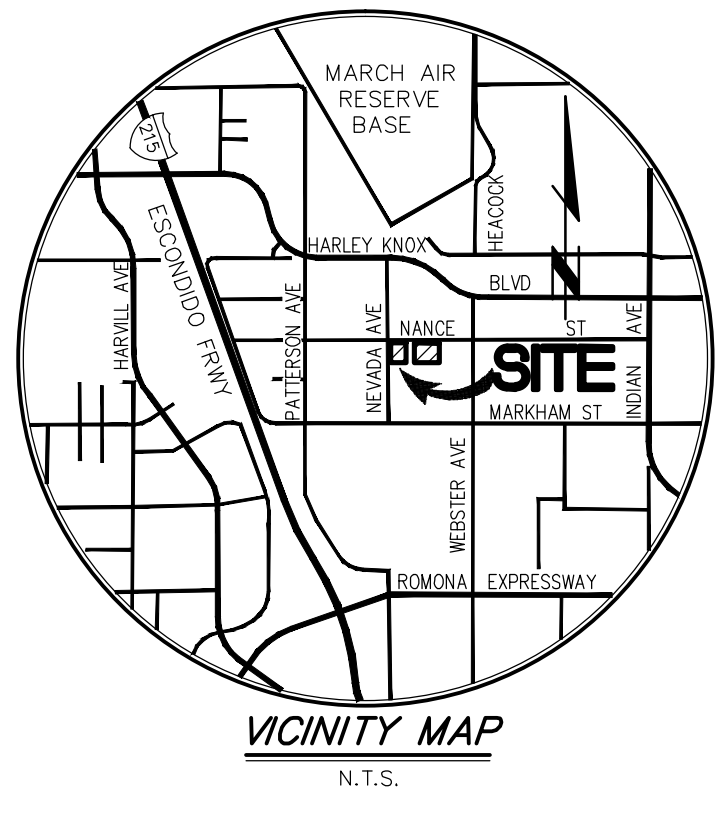
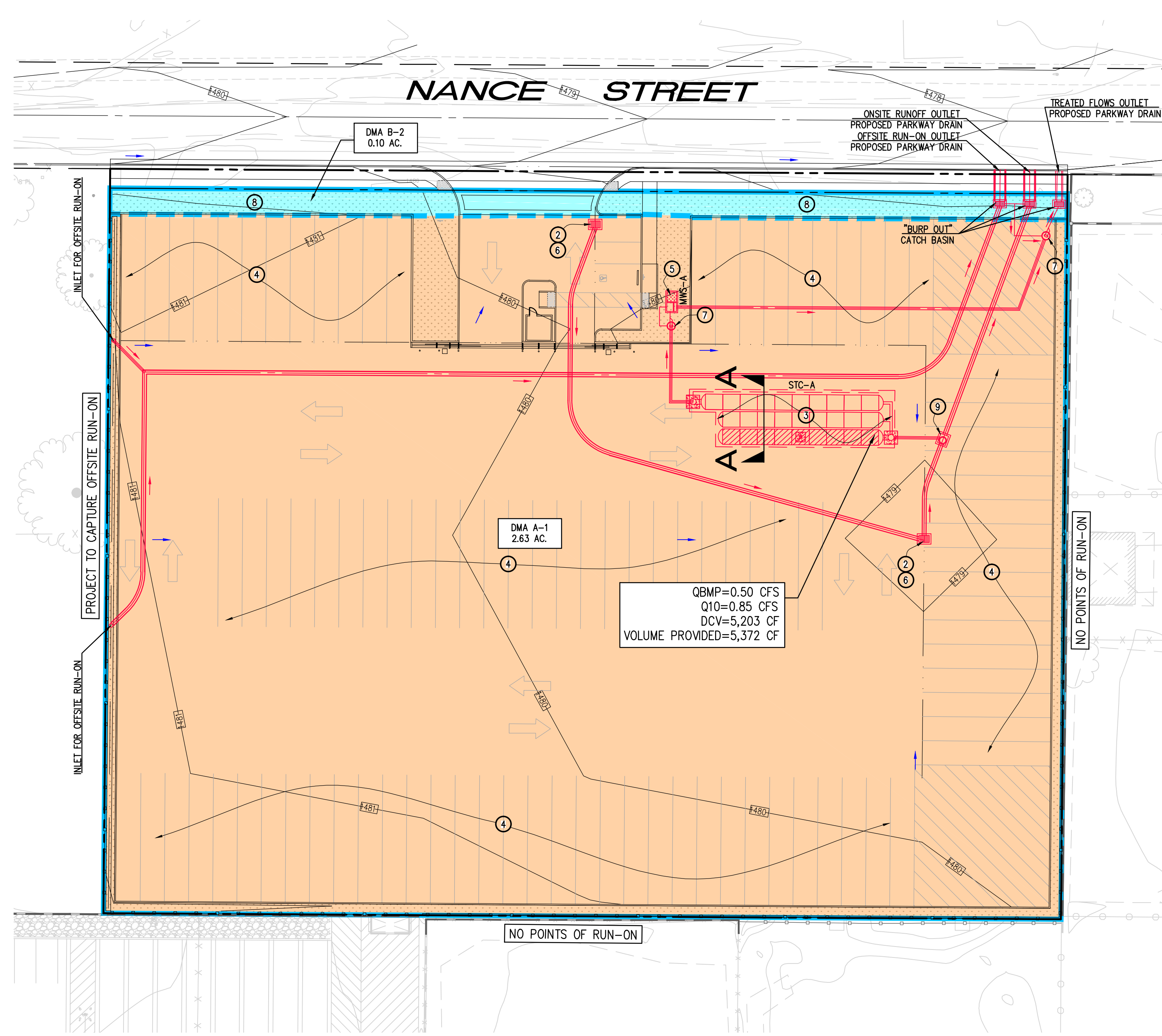

LEGEND

- ① NOT USED
- ② STORM DRAIN STENCIL
- ③ STORMTECH MC-3500 DETENTION CHAMBERS (STC)
- ④ PARKING LOT MAINTENANCE (SWEEPING)
- ⑤ PROPRIETARY BIOTREATMENT UNIT MODULAR WETLANDS SYSTEM (MWS)
- ⑥ DRAIN INSERT(S)
- ⑦ SUMP PUMP
- ⑧ SELF-TREATING LANDSCAPE
- ⑨ DIVERSION STRUCTURE

NOTE:

- BOUNDARY
- SUBAREAS
- SURFACE FLOW LINE
- SD FLOW LINE
- DMA A
- DMA B
- LANDSCAPE AREA

QBMP=0.50 CFS
 Q10=0.85 CFS
 DCV=5,203 CF
 VOLUME PROVIDED=5,372 CF

DMA Name or ID	Surface Type(s)	Area (Sq. Ft.)	Area (Acres)	DMA Type
A-1	Roofs/Conc/Asphalt	114,563	2.63	Type D
B-2	Ornamental Landscaping	4,356	0.10	Type A

SUMMARY TABLE

DMA	AREA (ACRES)	DCV (CF)	MODULAR WETLANDS SYSTEM (MWS)		MC-3500 STORMTECH CHAMBERS			TOTAL VOLUME PROVIDED (CF)
			MWS MODEL	LINEAR STATIC CAPACITY (CF)	DETENTION REQUIRED (CF)	DETENTION PROVIDED (CF)	# OF CHAMBERS	
A	2.63	5,203	MWS-L-4-8-V	81	5,122	5,291	28	5,372
TOTAL	2.63	5,203		81	5,122	5,291	28	5,372

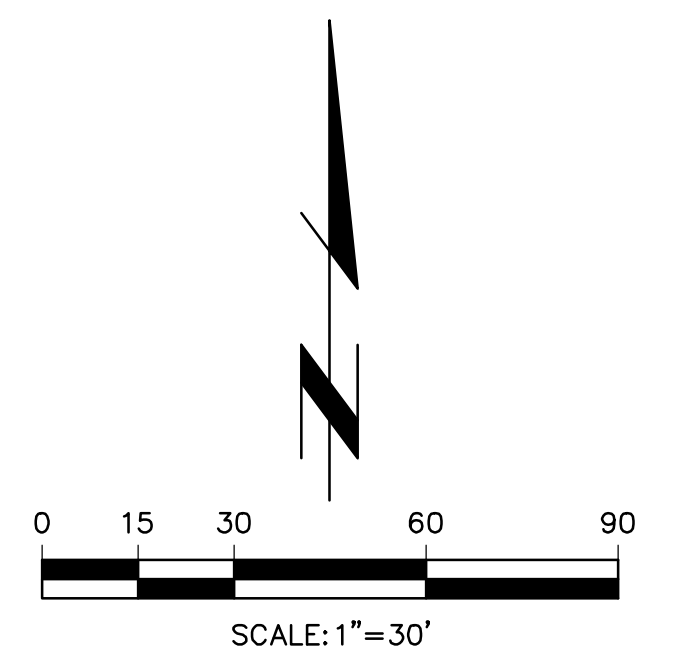

Last Update: 2/23/23
 C:\4100-4199\4130\4130BMPSTEMAP-EAST.dwg

CITY OF PERRIS
 PUBLIC WORKS DEPARTMENT

POST-CONSTRUCTION BMP SITE MAP

**PERRIS TRAILER YARD
 NANCE STREET
 P23-XXXX**

Designed by _____ Date _____
 Checked by _____ Date _____
 Approved by _____ Date _____
 Public Works Director R.C.E.

Sheet **1** of **3** Sheets

JN: 4130
 LOT DATE: 02/23/2023

PREPARED FOR:

LAKE CREEK INDUSTRIAL, LLC
 1302 BRITTANY CROSS RD.
 SANTA ANA, CALIFORNIA 92705
 PHONE: (949) 910-4616

PREPARED BY:

TEI Thienes Engineering, Inc.
 CIVIL ENGINEERING • LAND SURVEYING
 14349 FIRESTONE BOULEVARD
 LA MIRADA, CALIFORNIA 90638
 PH: (714) 321-1811 FAX: (714) 321-4173

Last Update: 02/23/2023
 C:\4100-4199\4130\4130BMPSTEMAP-EAST.dwg

**BIO CLEAN FULL CAPTURE FILTER
FOR USE IN GRATE INLETS**

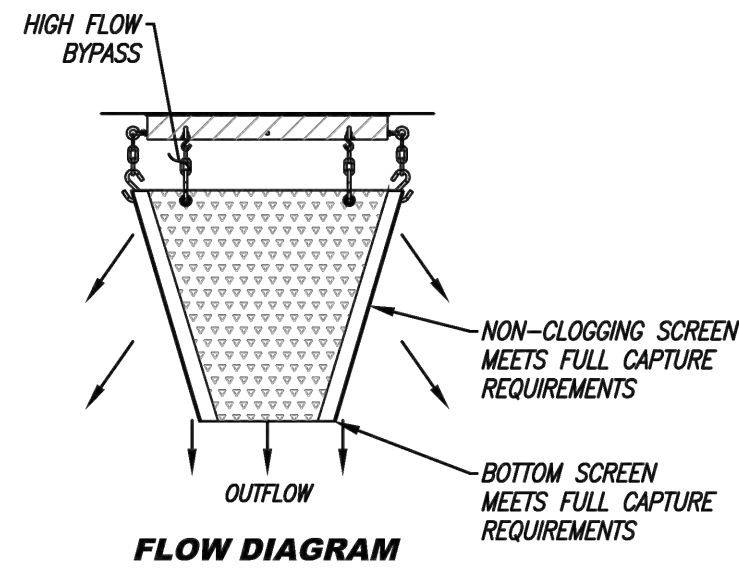
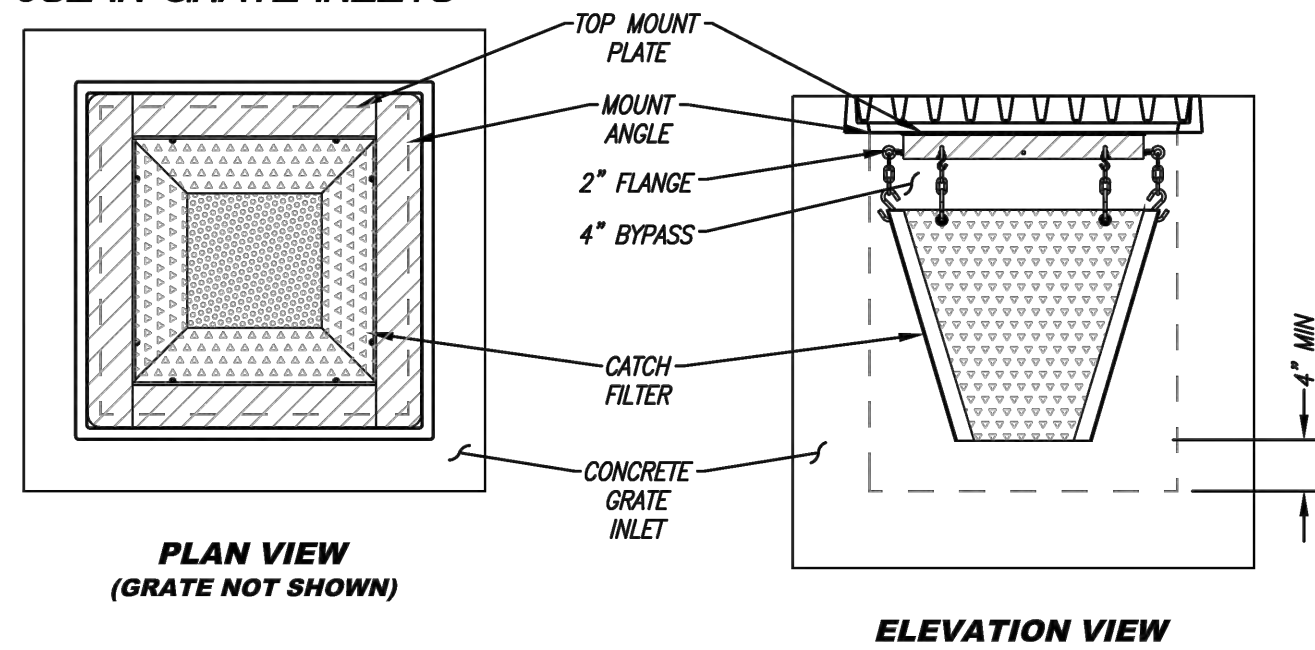

MODEL #	TREATMENT FLOW RATE (CFS)	BYPASS FLOW (CFS)	SOLIDS STORAGE CAPACITY (CF)
BIO-GRATE-FULL 12-12-12	1.04	1.24	0.15
BIO-GRATE-FULL 18-18-12	1.78	2.79	0.33
BIO-GRATE-FULL 24-24-12	2.70	4.96	0.59
BIO-GRATE-FULL 24-40-12	3.70	6.35	0.88
BIO-GRATE-FULL 24-24-24	7.31	4.96	1.22
BIO-GRATE-FULL 24-40-24	9.53	6.35	1.82
BIO-GRATE-FULL 36-36-24	11.93	7.74	2.73

INSTALLATION NOTES:

1. ALL HARDWARE, FLANGE, FRAME, SCREENS SHALL BE STAINLESS STEEL.
2. OPTIONAL HYDROCARBON BOOM SHALL BE 2" DIAMETER.
3. SEE PERFORMANCE REPORTS IN MANUFACTURERS SPECIFICATIONS.
4. OTHER STANDARD AND CUSTOM MODEL SIZES AVAILABLE - CONTACT BIO CLEAN FOR MORE INFORMATION.
5. BASED ON 37% OPEN AREA.
6. CONSIDERS A SAFETY FACTOR OF 2.0.
7. CONSIDERS A LOCAL DEPRESSION PONDING DEPTH OF 6 INCHES.
8. STORAGE CAPACITY BASED ON THE BASKET HALF FULL.
9. CONCRETE STRUCTURES SOLD SEPARATELY.

NOT TO SCALE

PROPRIETARY AND CONFIDENTIAL:
THE INFORMATION CONTAINED IN THIS DOCUMENT IS THE SOLE PROPERTY OF FORSTEN AND ITS COMPANIES. THIS DOCUMENT, NOR ANY PART THEREOF, MAY BE USED, REPRODUCED OR MODIFIED IN ANY MANNER WITHOUT THE WRITTEN CONSENT OF FORSTEN.



**GRATE INLET FILTER
FULL CAPTURE
STANDARD DETAIL**

SITE SPECIFIC DATA

PROJECT NAME	
PROJECT LOCATION	
STRUCTURE ID	
TREATMENT REQUIRED	
VOLUME BASED (CF)	FLOW BASED (CFS)
TREATMENT HGL AVAILABLE (FT)	
PEAK BYPASS REQUIRED (CFS) - IF APPLICABLE	
PIPE DATA	I.E. MATERIAL DIAMETER
INLET PIPE 1	
INLET PIPE 2	
OUTLET PIPE	
	PRETREATMENT BIOFILTRATION DISCHARGE
RIM ELEVATION	
SURFACE LOAD	PARKWAY OPEN PLANTER PARKWAY
FRAME & COVER	36" X 36" N/A N/A
WETLANDMEDIA VOLUME (CY)	2.03
WETLANDMEDIA DELIVERY METHOD	TBD
ORIFICE SIZE (DIA. INCHES)	#1.53"
MAXIMUM PICK WEIGHT (LBS)	15000
NOTES:	

INSTALLATION NOTES

1. CONTRACTOR TO PROVIDE ALL LABOR, EQUIPMENT, MATERIALS AND INCIDENTALS REQUIRED TO OVLAD AND INSTALL THE SYSTEM AND APPURTENANCES IN ACCORDANCE WITH THIS DRAWING AND THE MANUFACTURERS SPECIFICATIONS, UNLESS OTHERWISE STATED IN MANUFACTURERS CONTRACT.
2. UNIT MUST BE INSTALLED ON LEVEL BASE. MANUFACTURER RECOMMENDS A MINIMUM 6" LEVEL ROCK BASE UNLESS SPECIFIED BY THE PROJECT ENGINEER. CONTRACTOR IS RESPONSIBLE TO VERIFY PROJECT ENGINEERS RECOMMENDED BASE SPECIFICATIONS.
3. ALL PIPES MUST BE FLUSH WITH INSIDE SURFACE OF CONCRETE. (PIPES CANNOT INTRUDE BEYOND FLUSH). INVERT OF OUTFLOW PIPE MUST BE FLUSH WITH DISCHARGE CHAMBER FLOOR. ALL CAPS AROUND PIPES SHALL BE SEALED WATER TIGHT WITH A NON-SHRINK GROUT PER MANUFACTURERS STANDARD CONNECTION DETAIL AND SHALL MEET OR EXCEED REGIONAL PIPE CONNECTION STANDARDS.
4. CONTRACTOR TO SUPPLY AND INSTALL ALL EXTERNAL CONNECTING PIPES.
5. CONTRACTOR RESPONSIBLE FOR INSTALLATION OF ALL RISERS, MANHOLES, AND HATCHES. CONTRACTOR TO GROUT ALL MANHOLES AND HATCHES TO MATCH FINISHED SURFACE UNLESS SPECIFIED OTHERWISE.
6. DRIP OR SPRAY IRRIGATION REQUIRED ON ALL UNITS WITH VEGETATION.

GENERAL NOTES

1. MANUFACTURER TO PROVIDE ALL MATERIALS UNLESS OTHERWISE NOTED.
2. ALL DIMENSIONS, ELEVATIONS, SPECIFICATIONS AND CAPACITIES ARE SUBJECT TO CHANGE. FOR PROJECT SPECIFIC DRAWINGS DETAILING EXACT DIMENSIONS, WEIGHTS AND ACCESSORIES PLEASE CONTACT MANUFACTURER.

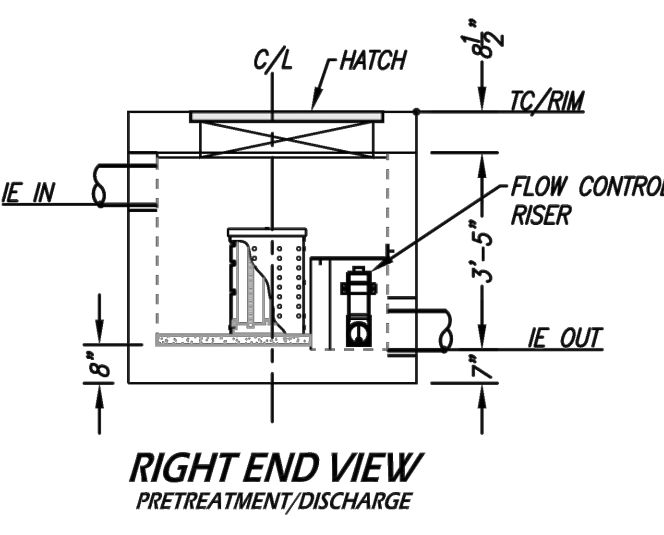
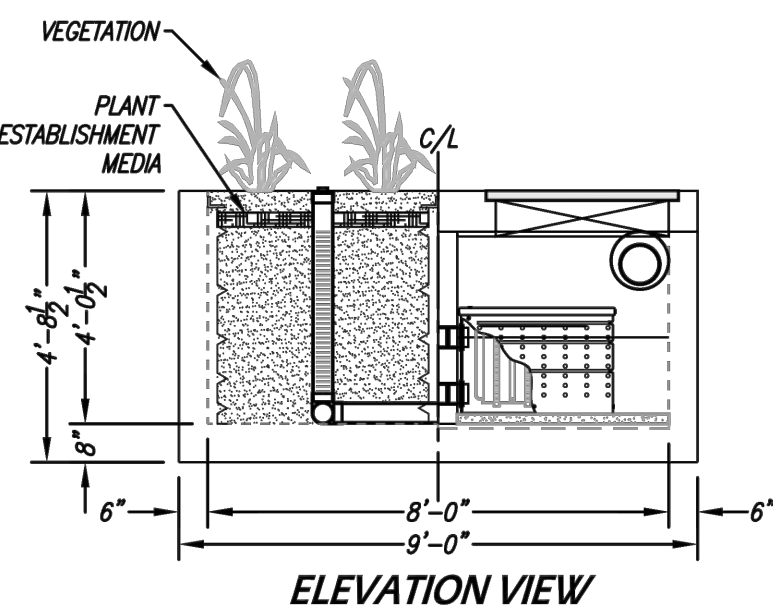
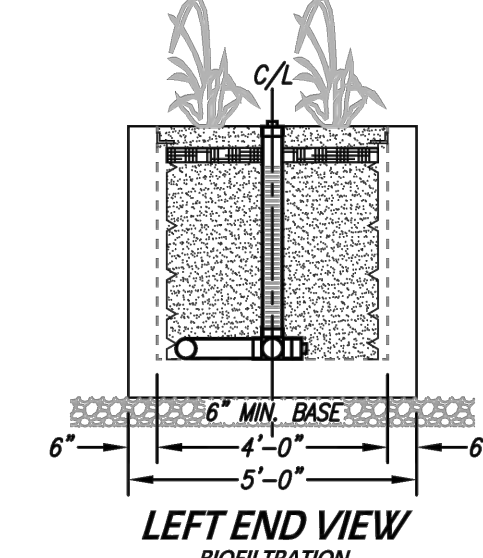
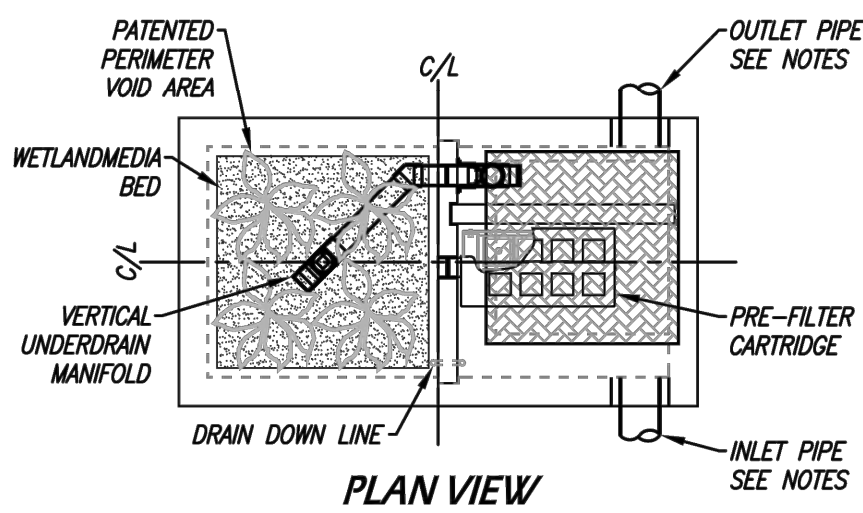

TREATMENT FLOW (CFS)	0.115
OPERATING HEAD (FT)	3.4
PRETREATMENT LOADING RATE (GPM/SF)	TBD
WETLAND MEDIA LOADING RATE (GPM/SF)	1.0

**MWS-L-4-8-V
STORMWATER BIOFILTRATION SYSTEM
STANDARD DETAIL**

THE PRODUCT DESCRIBED MAY BE PROTECTED BY ONE OR MORE OF THE FOLLOWING US PATENTS: 7,425,262; 7,470,262; 7,674,376; 8,303,876; RELATED FOREIGN PATENTS OR OTHER PATENTS PENDING.

PROPRIETARY AND CONFIDENTIAL:
THE INFORMATION CONTAINED IN THIS DRAWING IS THE SOLE PROPERTY OF MODULAR WETLANDS SYSTEMS. ANY REPRODUCTION IN PART OR AS A WHOLE WITHOUT THE WRITTEN PERMISSION OF MODULAR WETLANDS SYSTEMS IS PROHIBITED.



SAMPLE STORM DRAIN STENCIL

Last Update: 2/23/23
C:\4100-4199\4130\4130BMPSTEMAP-EAST.dwg

CITY OF PERRIS
PUBLIC WORKS DEPARTMENT

**POST-CONSTRUCTION
BMP SITE MAP**

**PERRIS TRAILER YARD
NANCE STREET
P23-XXXX**

PREPARED FOR:

LAKE CREEK INDUSTRIAL, LLC
1302 BRITTANY CROSS RD.
SANTA ANA, CALIFORNIA 92705
PHONE: (949) 910-4616

PREPARED BY:

Tai Thienes Engineering, Inc.
CIVIL ENGINEERING *LAND SURVEYING
14349 TRESS-TONGE BOULEVARD
LA MIRADA, CALIFORNIA 90638
PH: (714)321-1811 FAX: (714)321-1713

Designed by _____	Approved by _____	Date _____
Date _____		
Checked by _____		
Date _____		
Designed by _____	Public Works Director _____	R.C.E. _____
Date _____		
Checked by _____		
Date _____		

Sheet **2** of **3** Sheets

JN: 4130

LOT DATE: 02/23/2023
Last Update: 02/22/2023
C:\4100-4199\4130\4130BMPSTEMAP-EAST.dwg

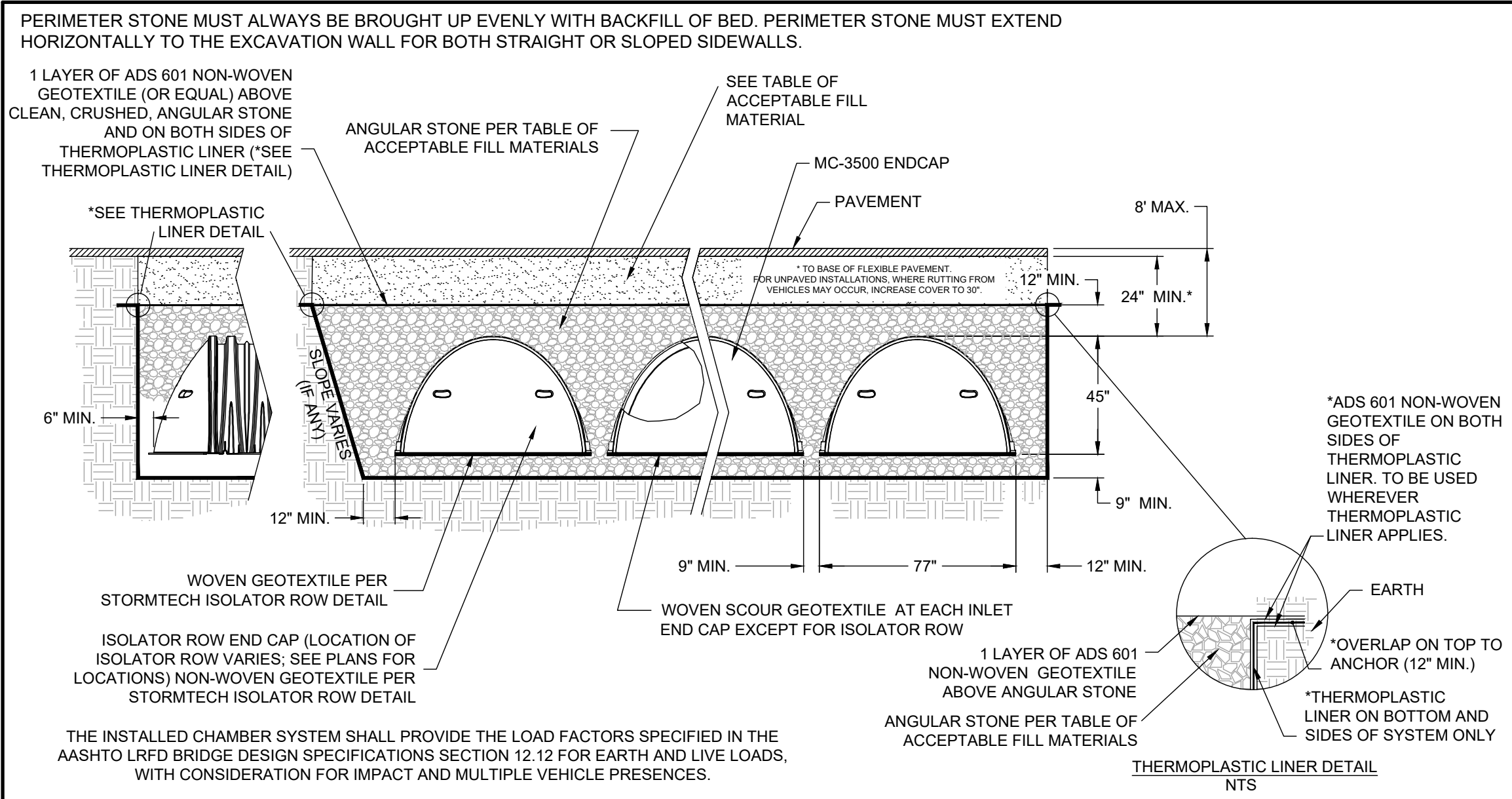

ST 1.0 MC-3500 TYPICAL CROSS SECTION

ACCEPTABLE FILL MATERIALS: STORMTECH MC-3500 CHAMBER SYSTEMS

MATERIAL LOCATION	DESCRIPTION	AASHTO M43 DESIGNATION(1)	COMPACTION/DENSITY REQUIREMENT
(D) FILL MATERIAL FOR LAYER 'D' STARTS FROM THE TOP OF THE 'C' LAYER TO THE BOTTOM OF FLEXIBLE PAVEMENT OR UNPAVED FINISHED GRADE ABOVE. NOTE THAT PAVEMENT SUBBASE MAY BE PART OF THE 'D' LAYER.	ANY SOIL/ROCK MATERIALS, NATIVE SOILS, OR PER ENGINEER'S PLANS. CHECK PLANS FOR PAVEMENT SUBBASE REQUIREMENTS.	N/A	PREPARE PER ENGINEER'S PLANS. PAVED INSTALLATIONS MAY HAVE STRINGENT MATERIAL AND PREPARATION REQUIREMENTS.
(C) FILL MATERIAL FOR LAYER 'C' STARTS FROM THE TOP OF THE EMBEDMENT STONE ('E' LAYER) TO 24" (610 mm) ABOVE THE TOP OF THE CHAMBER. NOTE THAT PAVEMENT SUBBASE MAY BE A PART OF THIS LAYER.	GRANULAR WELL-GRADED SOIL/AGGREGATE MIXTURES, < 35% FINES. MOST PAVEMENT SUBBASE MATERIALS CAN BE USED IN LIEU OF THIS LAYER.	3, 357, 4, 467, 5, 56, 57, 6, 67, 68, 7, 78, 8, 89, 9, 10	BEGIN COMPACTION AFTER 24" (610 mm) OF MATERIAL OVER THE CHAMBERS IS REACHED. COMPACT ADDITIONAL LAYERS IN 12" (305 mm) MAX LIFTS TO A MIN. 95% STANDARD PROCTOR DENSITY.
(E) EMBEDMENT STONE SURROUNDING THE CHAMBERS FROM THE FOUNDATION STONE TO THE 'C' LAYER ABOVE.	CLEAN, CRUSHED, ANGULAR STONE. NOMINAL SIZE DISTRIBUTION BETWEEN 3/4" - 2 INCH (19 - 51 mm)	3, 4	NO COMPACTION REQUIRED.
(A) FOUNDATION STONE BELOW CHAMBERS FROM THE SUBGRADE UP TO THE FOOT (BOTTOM) OF THE CHAMBER.	CLEAN, CRUSHED, ANGULAR STONE. NOMINAL SIZE DISTRIBUTION BETWEEN 3/4" - 2 INCH (19 - 51 mm)	3, 4	PLATE COMPACT OR ROLL TO ACHIEVE A 95% STANDARD PROCTOR DENSITY(2).

PLEASE NOTE:
1. THE LISTED AASHTO DESIGNATIONS ARE FOR GRADING ONLY. THE STONE MUST ALSO BE CLEAN, CRUSHED, ANGULAR, FOR EXAMPLE, A SPECIFICATION FOR #4 STONE WOULD STATE: "CLEAN, CRUSHED, ANGULAR NO. 4 (AASHTO M43) STONE".
2. AS AN ALTERNATE TO PROCTOR TESTING AND FIELD DENSITY MEASUREMENTS ON OPEN GRADED STONE, STORMTECH COVERAGE REQUIREMENTS ARE MET FOR 'A' LOCATION MATERIALS WHEN PLACED AND COMPACTED IN 9" (MAX) LIFTS USING TWO FULL COVERAGES WITH AN APPROPRIATE COMPACTOR.

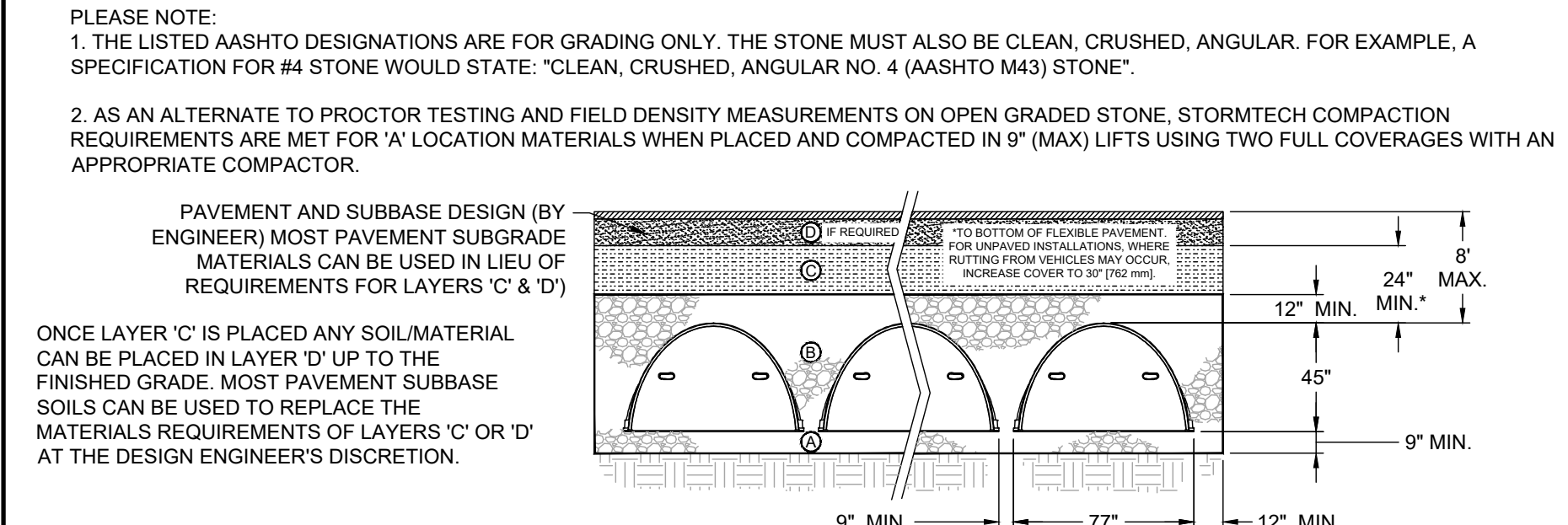

ST 3.0 ACCEPTABLE FILL MATERIALS

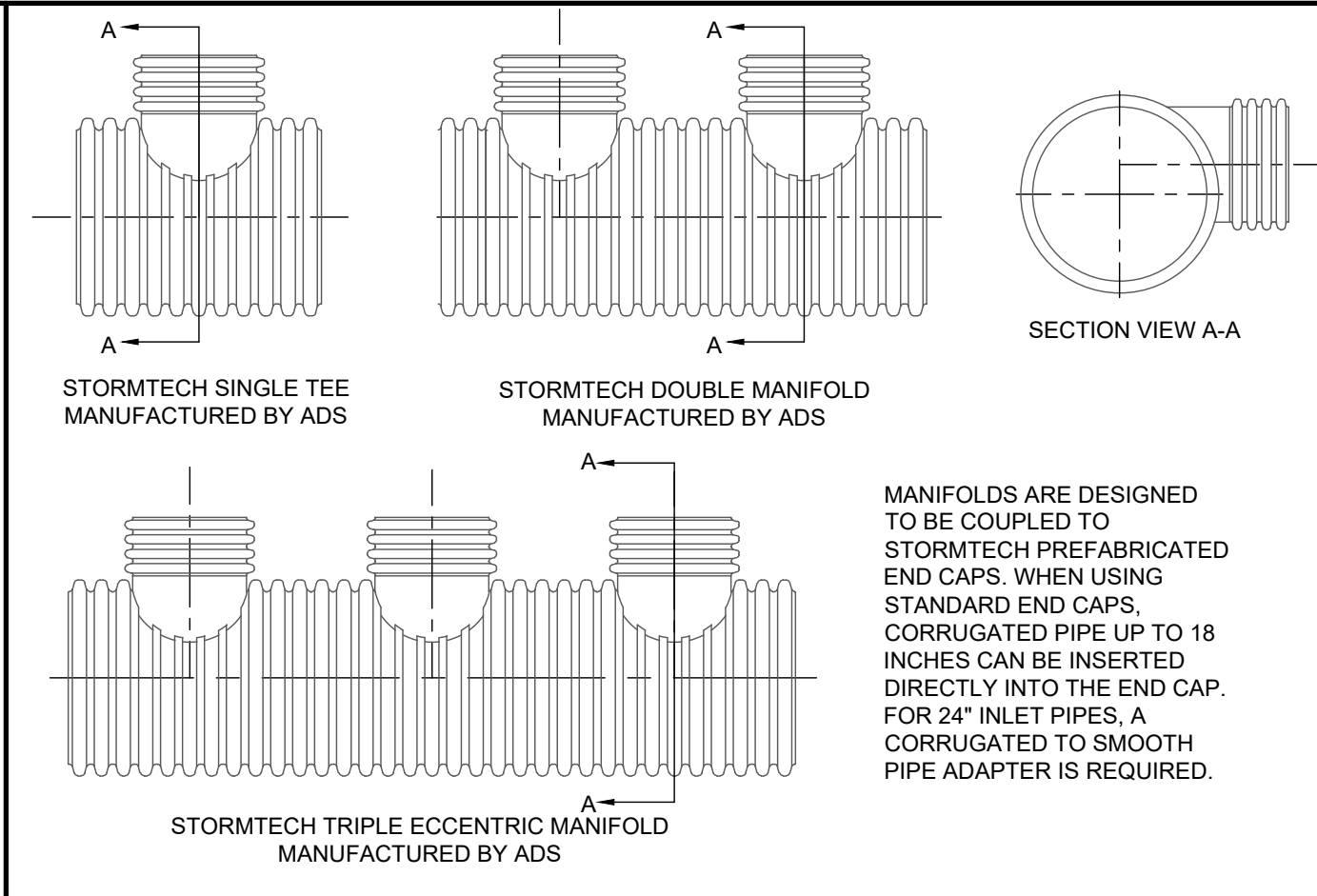

ST 7.0 ADS MANIFOLD DETAILS

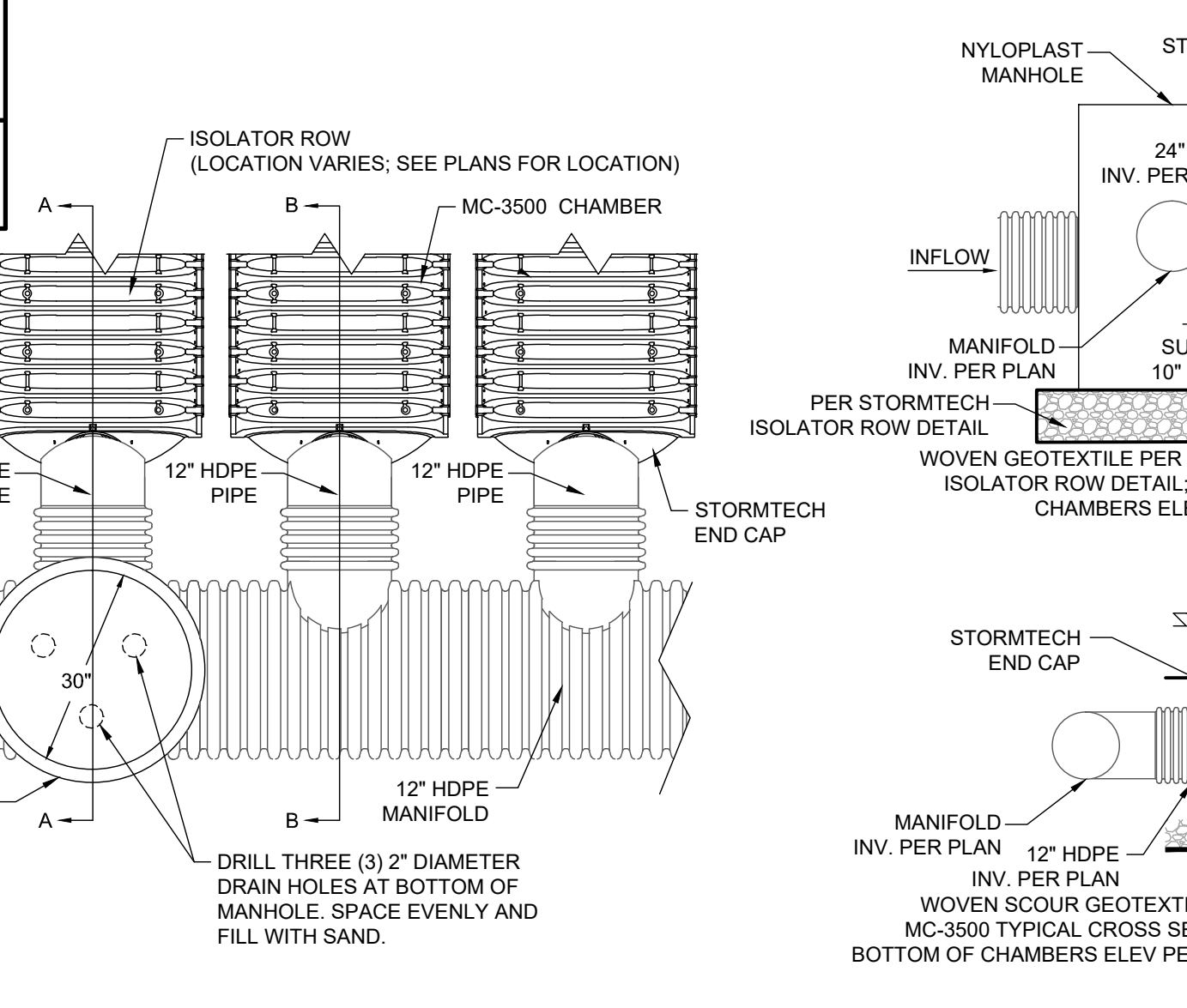

ST 8.0 STORMTECH ELEVATIONS

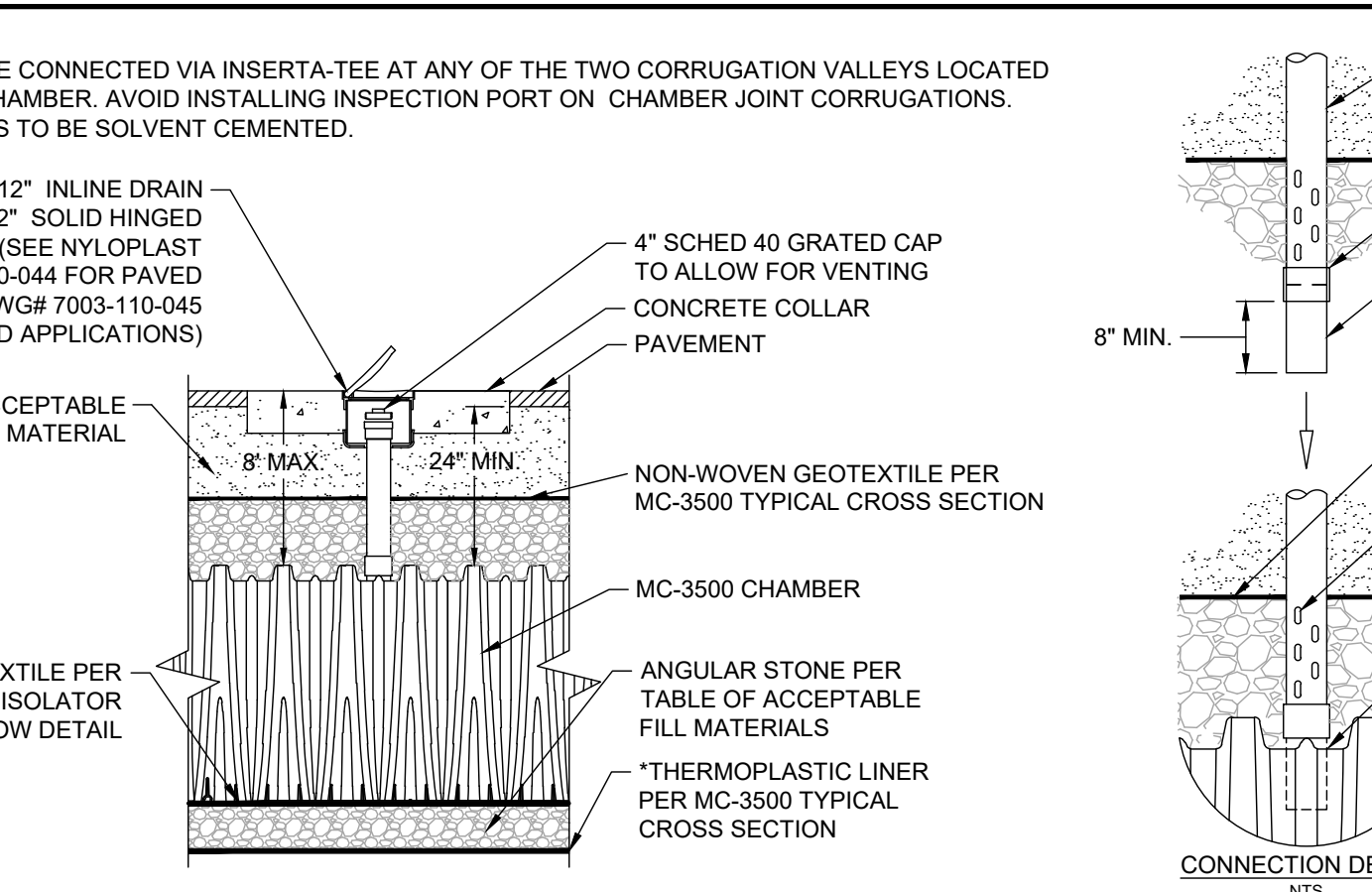

ST 5.0 INSPECTION PORT DETAIL

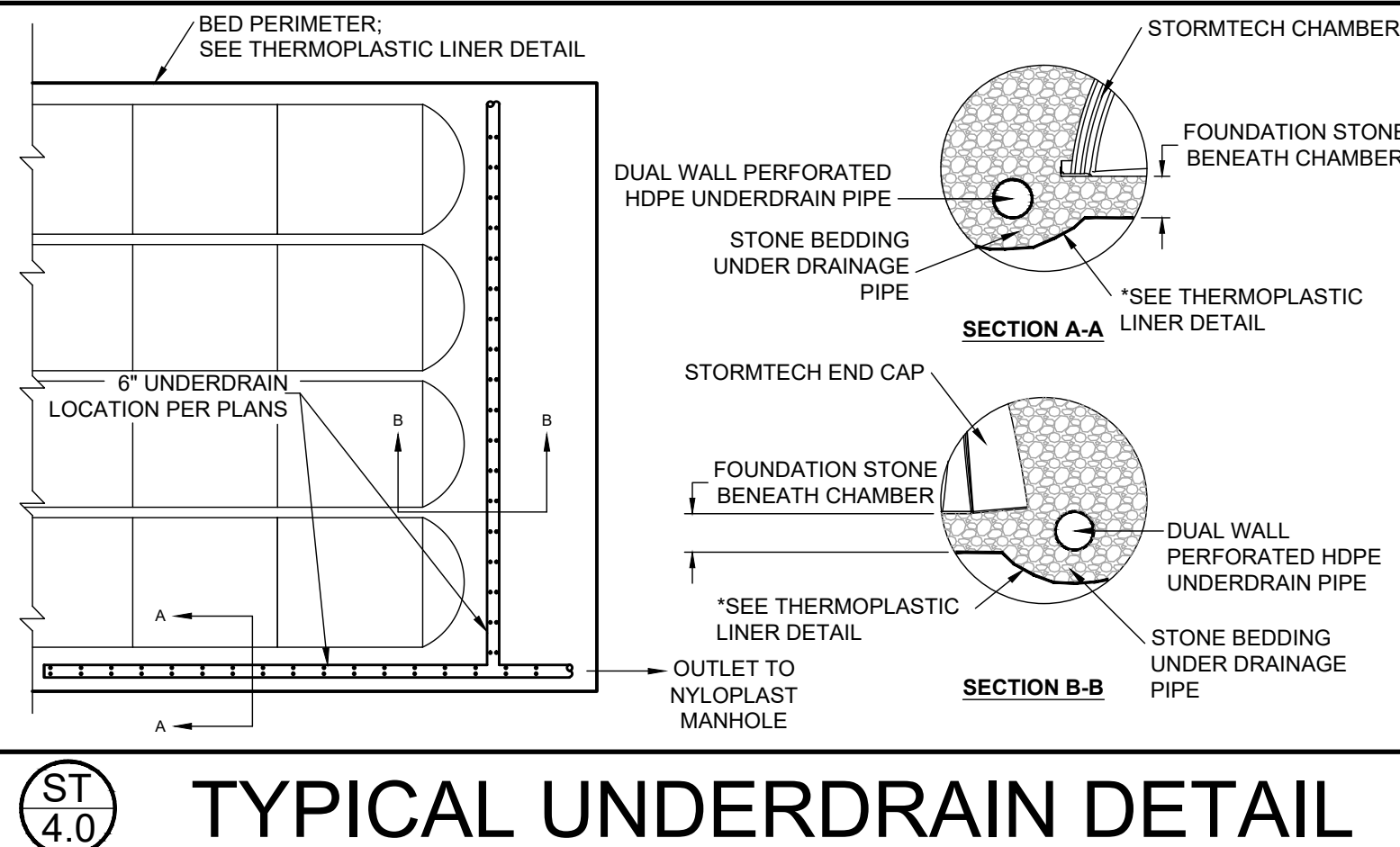

ST 4.0 TYPICAL UNDERDRAIN DETAIL

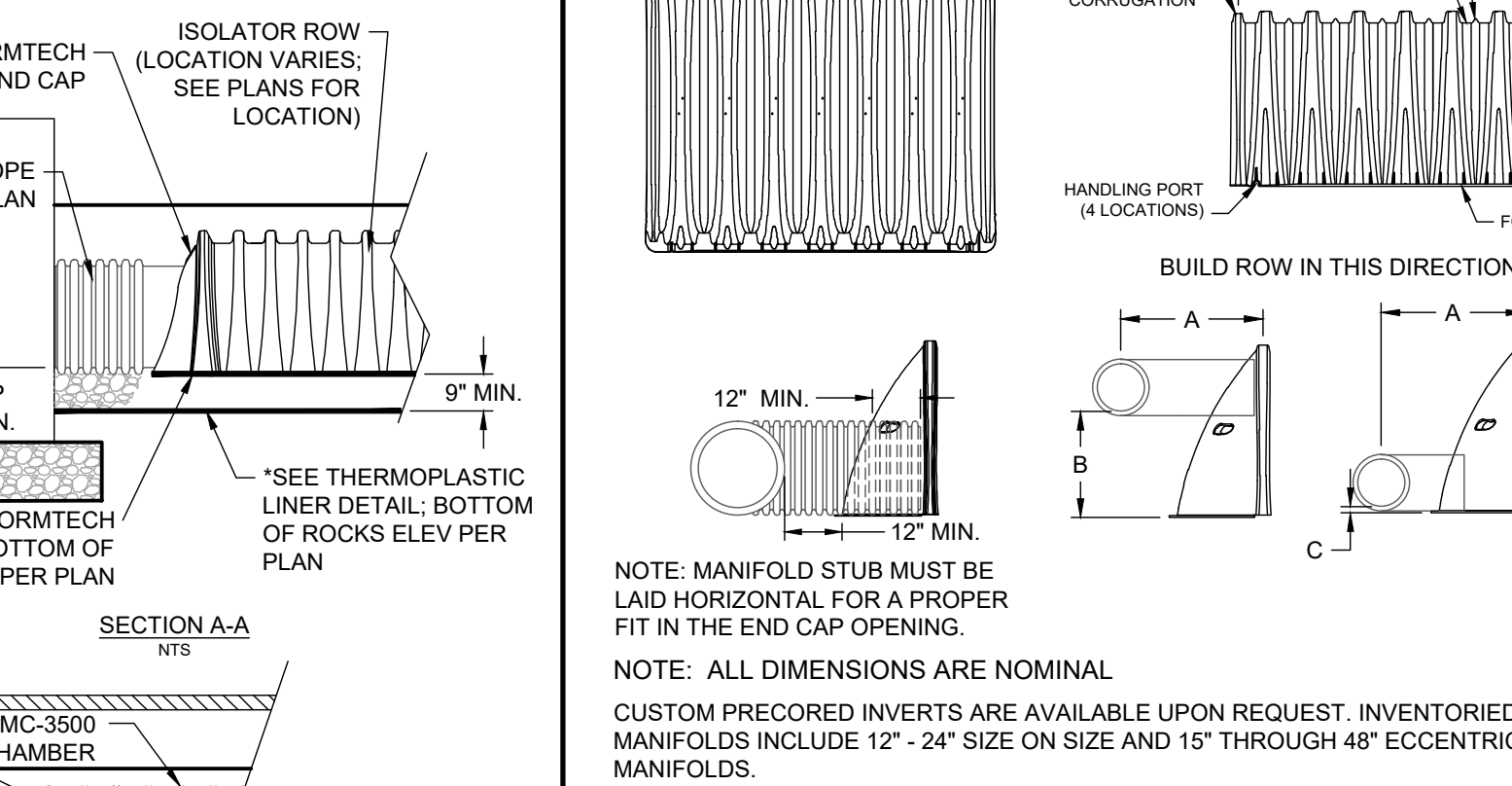

ST 9.0 TECHNICAL DETAILS

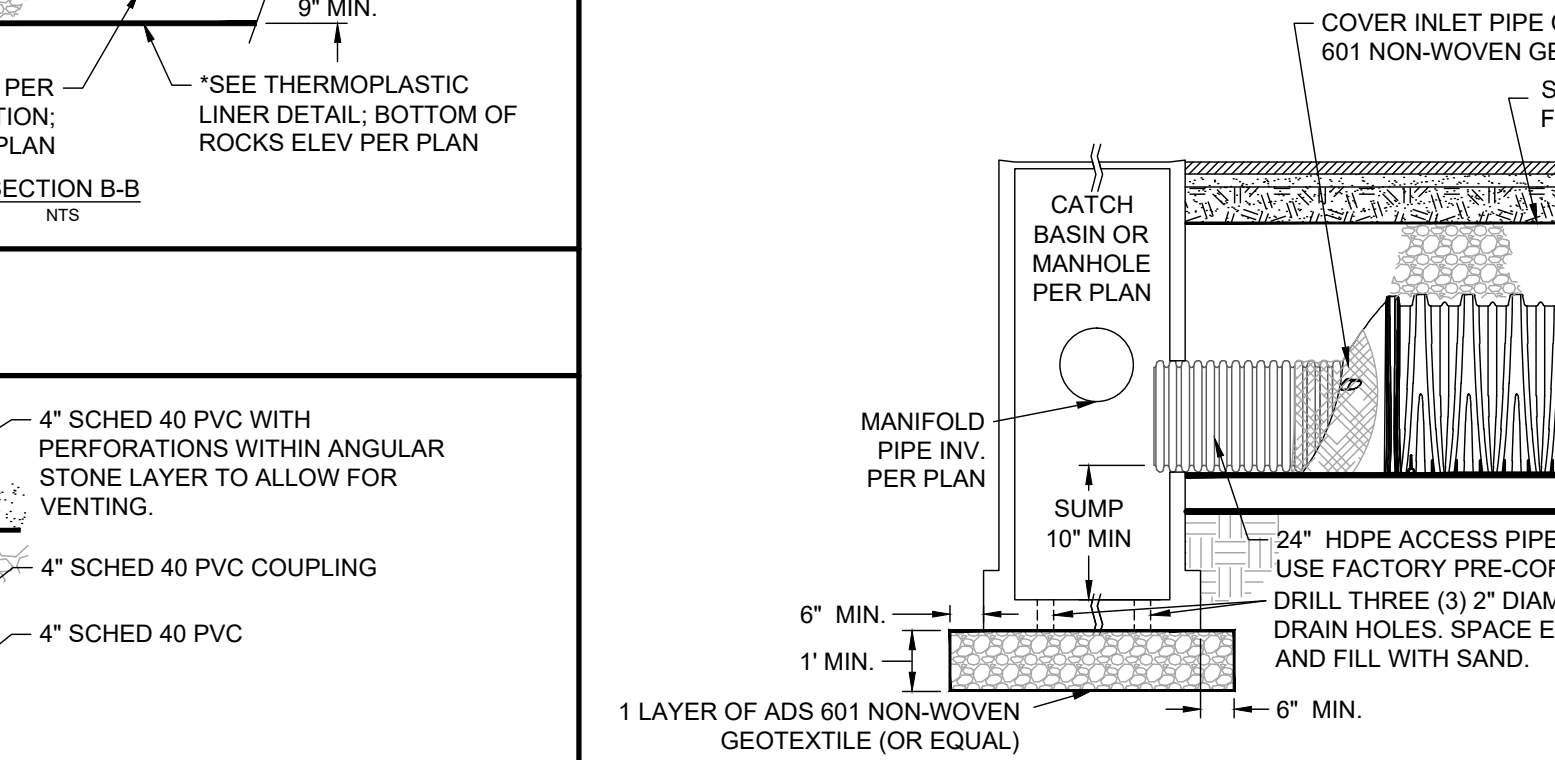

ST 6.0 STORMTECH ISOLATOR ROW DETAIL

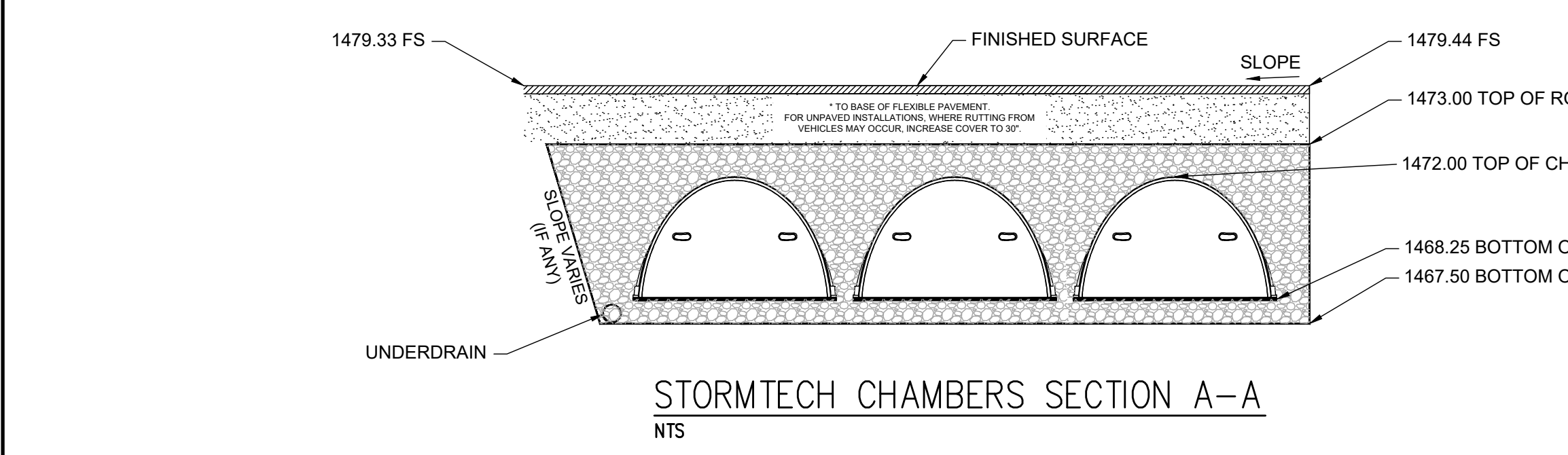

ST 1.0 PERIMETER STONE MUST ALWAYS BE BROUGHT UP EVENLY WITH BACKFILL OF BED. PERIMETER STONE MUST EXTEND HORIZONTALLY TO THE EXCAVATION WALL FOR BOTH STRAIGHT OR SLOPED SIDEWALLS.

GENERAL NOTES:

- ALL DESIGN SPECIFICATIONS FOR STORMTECH CHAMBERS SHALL BE IN ACCORDANCE WITH THE STORMTECH DESIGN MANUAL.
- THE INSTALLATION OF STORMTECH CHAMBERS SHALL BE IN ACCORDANCE WITH THE LATEST STORMTECH INSTALLATION INSTRUCTIONS.
- THE CONTRACTOR IS ADVISED TO REVIEW AND UNDERSTAND THE INSTALLATION INSTRUCTIONS PRIOR TO BEGINNING SYSTEM INSTALLATION. CALL 1 (888) 892-2694 OR VISIT WWW.STORMTECH.COM TO RECEIVE A COPY OF THE LATEST STORMTECH INSTALLATION INSTRUCTIONS.
- THE INSTALLED CHAMBER SYSTEM SHALL PROVIDE THE LOAD FACTORS SPECIFIED IN THE AASHTO LRFD BRIDGE DESIGN SPECIFICATIONS SECTION 12.12 FOR EARTH AND LIVE LOADS WITH CONSIDERATION FOR IMPACT AND MULTIPLE VEHICLE PRESENCE.
- THE CONTRACTOR IS REQUIRED TO CALL THE CIVIL ENGINEER AT (714) 521-4811 TO SCHEDULE A FREE PRE-CONSTRUCTION MEETING WITH THE MANUFACTURER.

THERMOPLASTIC NOTES:

- ALL THERMOPLASTIC LINERS SHALL BE PROTECTED FROM ANGULAR AGGREGATE ON THE WATER SIDE AND FROM PROTRUSIONS ON THE SOIL SIDE BY PLACING A NON-WOVEN GEOTEXTILE ON EACH SIDE OF THE THERMOPLASTIC.
- THE THERMOPLASTIC LINER SHALL BE 30 MIL PVC.
- THE THERMOPLASTIC LINER SHALL BE ONE CONTINUOUS PIECE (PREFABRICATED). HOWEVER, IF NOT POSSIBLE, SOLVENT WELD PVC.

ST 2.0 STORMTECH NOTES

NOMINAL MC-3500 CHAMBER SPECIFICATIONS

SIZE (L x W x H)	90" x 77" x 45"
CHAMBER STORAGE	109.9 CUBIC FEET
MINIMUM INSTALLED STORAGE	178.9 CUBIC FEET
WEIGHT	134 lbs.

NOMINAL MC-3500 END CAP SPECIFICATIONS

SIZE (L x W x H)	26.5" x 71" x 45.1"
ENDCAP STORAGE	15.6 CUBIC FEET
MINIMUM INSTALLED STORAGE	46.9 CUBIC FEET
WEIGHT	43 lbs.

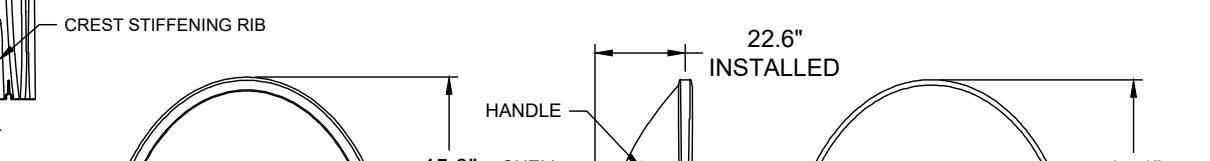

ST 6.0 CITY OF PERRIS PUBLIC WORKS DEPARTMENT

POST-CONSTRUCTION BMP SITE MAP

PERRIS TRAILER YARD NANCE STREET P23-XXXXX

Designed by _____ Date _____
 Checked by _____ Date _____
 Approved by _____ Date _____
 Public Works Director R.C.E.

Sheet **3** of **3** Sheets

DATE: 02/23/2023

PREPARED FOR:
LAKE CREEK INDUSTRIAL, LLC
1302 BRITANNY CROSS RD.
SANTA ANA, CALIFORNIA 92705
PHONE: (949) 910-4616

PREPARED BY:
TEI Thienes Engineering, Inc.
CIVIL ENGINEERING • LAND SURVEYING
14349 TRESTLE BOULEVARD
LA MIRADA, CALIFORNIA 90638
PH: (714) 321-1811 FAX: (714) 321-1713

JN: 4130
DATE: 02/23/2023

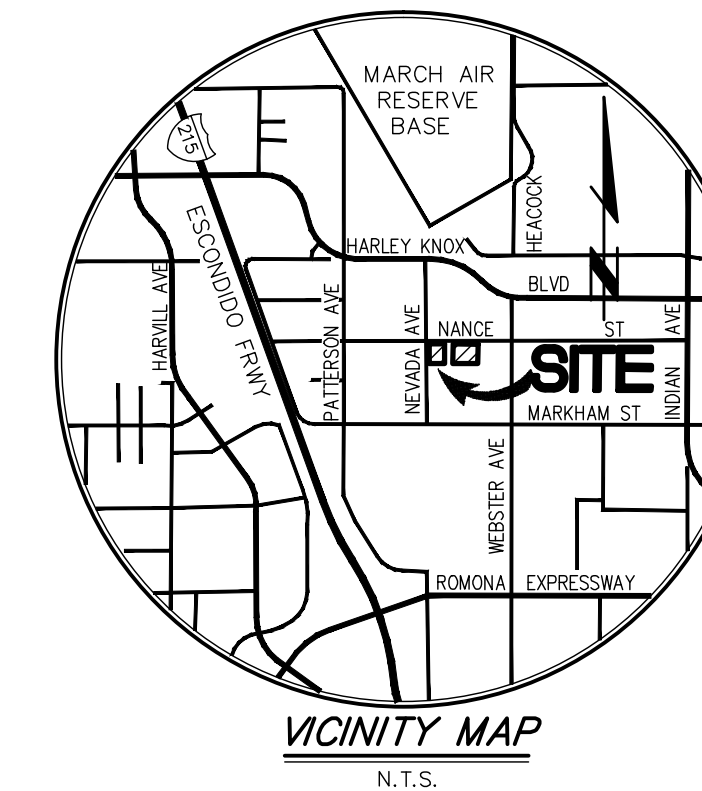

EARTHWORK BALANCE CALCULATIONS		1/25/2023	
PROJECT:	LAKE CREEK INDUSTRIAL LLC - PERRIS TRAILER YARD 'WEST LOT'	QUANTITY	UNITS
JOB#	4130		
K. SITE AREA:	79,156	SF	
L. SUBSIDENCE FACTOR:	0.1	%	
M. SHRINKAGE FACTOR:	10	%	
N. SITE STRIPPING FACTOR:	0.05		
O. OVEREXCAVATION:	1,083	CY	
A. CALCULATED CUT:	1,000	CY	
ADDITION SLAB CUT:	-	CY	
FOOTING AND UTILITY SPOILS	207	CY	
RECYCLE MATERIAL	-	CY	
UGS-WQMP	239	CY	
TOTAL CUT: (A+B)	1,446	CY	
D. CALCULATED FILL:	900	CY	
E. LIGHT PAVING FILL:	-	CY	
F. SUBSIDENCE: (LxK)/27=	147	CY	
G. SHRINKAGE: (M/100)C=	145	CY	
H. SITE STRIPPING	147	CY	
I. OVEREXCAVATION SHRINKAGE	108	CY	
TOTAL FILL: (D+E+F+G+H)=	1,446	CY	
K. TOTAL (IMPORT) OR EXPORT:	(0)	CY	
SITE ADJUSTMENT		(0.00)	

EARTHWORK BALANCE CALCULATIONS		1/25/2023	
PROJECT:	LAKE CREEK INDUSTRIAL LLC - PERRIS TRAILER YARD 'EAST LOT'	QUANTITY	UNITS
JOB#	4130		
K. SITE AREA:	118,782	SF	
L. SUBSIDENCE FACTOR:	0.1	%	
M. SHRINKAGE FACTOR:	10	%	
N. SITE STRIPPING FACTOR:	0.05		
O. OVEREXCAVATION:	-	CY	
A. CALCULATED CUT:	1,000	CY	
ADDITION SLAB CUT:	-	CY	
FOOTING AND UTILITY SPOILS	186	CY	
RECYCLE MATERIAL	-	CY	
UGS-WQMP	353	CY	
TOTAL CUT: (A+B)	1,539	CY	
D. CALCULATED FILL:	755	CY	
E. LIGHT PAVING FILL:	-	CY	
F. SUBSIDENCE: (LxK)/27=	440	CY	
G. SHRINKAGE: (M/100)C=	146	CY	
H. SITE STRIPPING	198	CY	
I. OVEREXCAVATION SHRINKAGE	-	CY	
TOTAL FILL: (D+E+F+G+H)=	1,539	CY	
K. TOTAL (IMPORT) OR EXPORT:	(0)	CY	
SITE ADJUSTMENT		(0.00)	

HATCH LEGEND:

- PROPOSED NANCE STREET ASPHALT PAVEMENT. (NORTH PROJECT)
- PROPOSED CONCRETE INTERSECTION APPROACH. (NORTH PROJECT)
- PROPOSED NANCE STREET ASPHALT PAVEMENT ADDITION. (SOUTH PROJECT)
- PROPOSED CONCRETE WITH DECORATIVE FINISH.

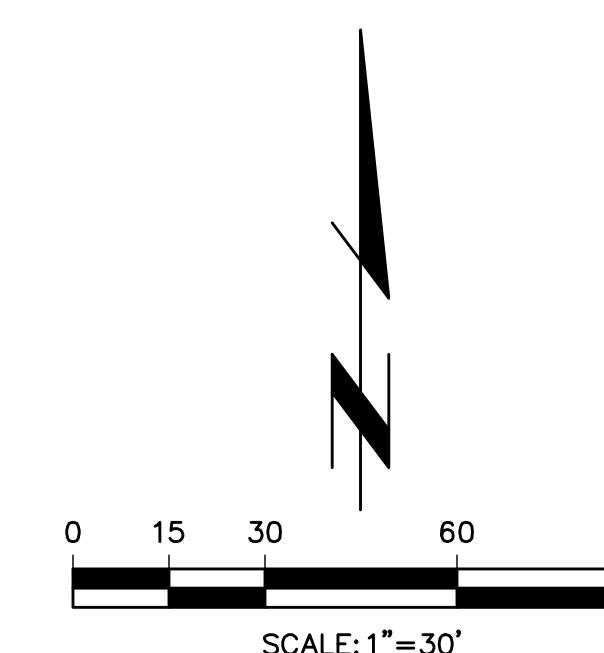

CITY OF PERRIS
PUBLIC WORKS DEPARTMENT
CONCEPTUAL GRADING PLAN
PERRIS TRAILER YARD
NANCE ST. AND NEVADA AVE.

Designed by	Approved by	Date
Checked by	Public Works Director	R.C.E. XXXXX
Designed by		
Checked by		

Sheet **1** of **4** Sheets

PREPARED FOR:
LAKE CREEK INDUSTRIAL, LLC
1302 BRITANNY CROSS RD.
SANTA ANA, CA. 92705
CONTACT: BOB KUBICHEK

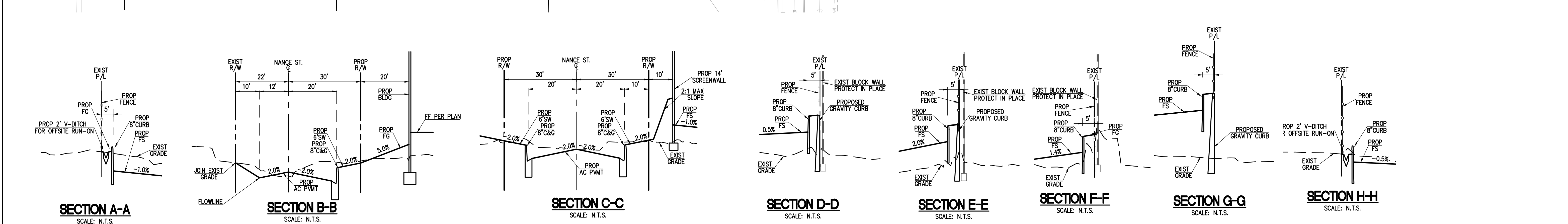
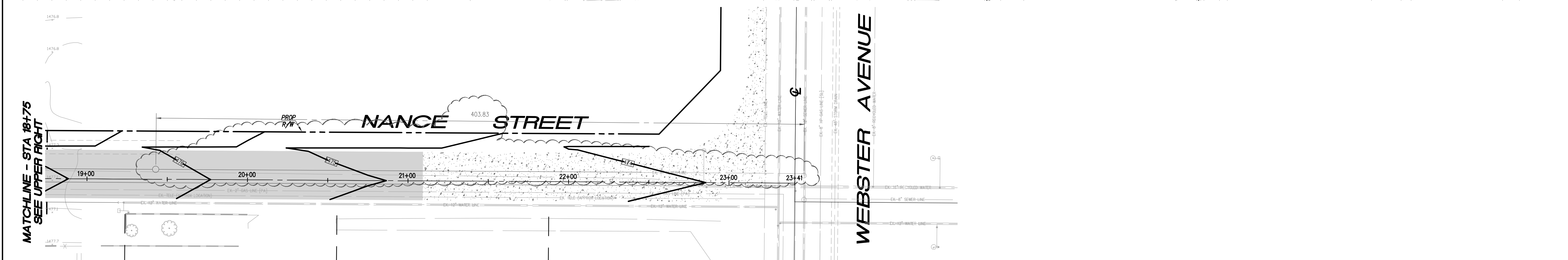
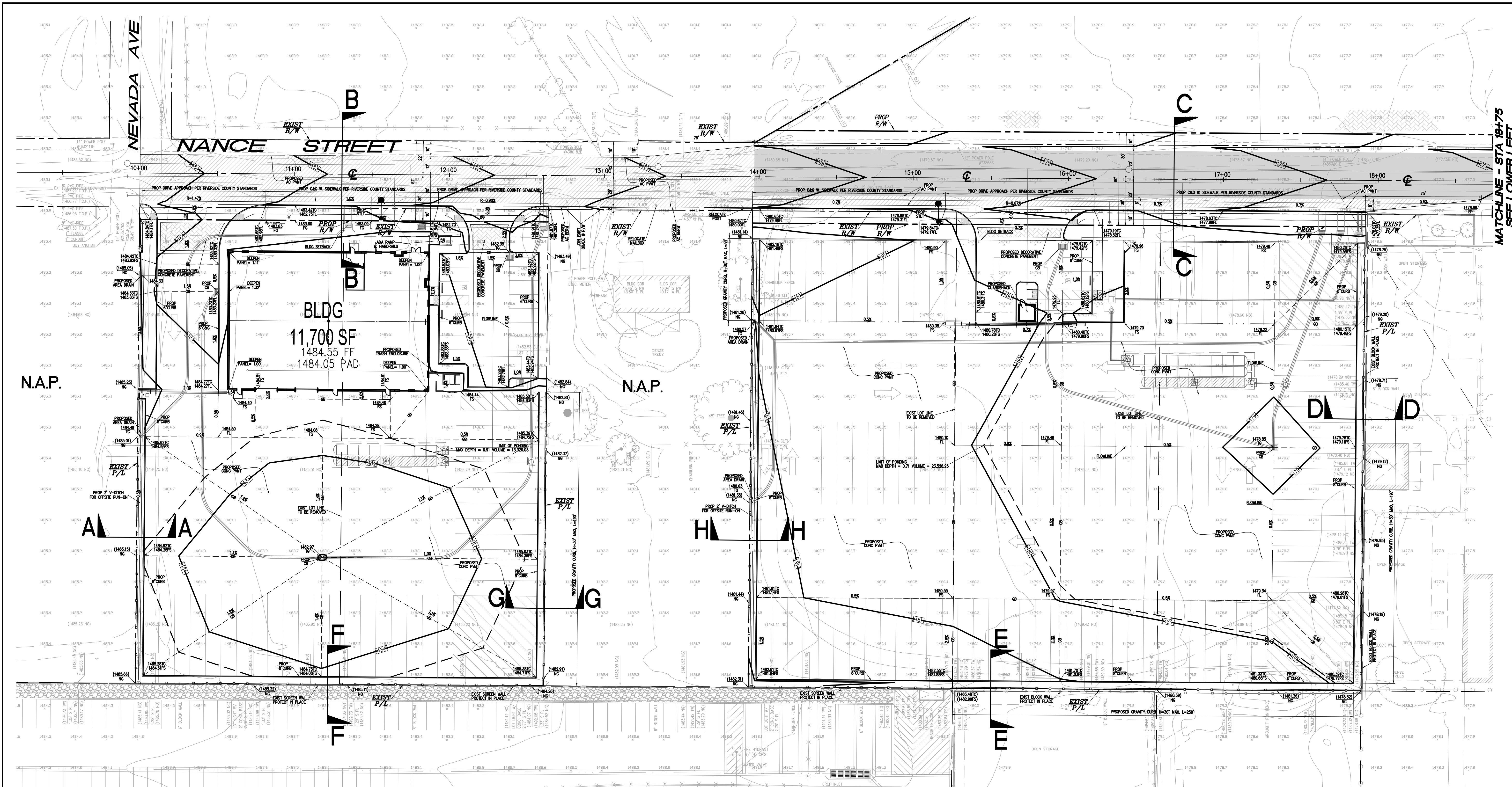

PLT DATE: 02/27/2023
JOB: 4130

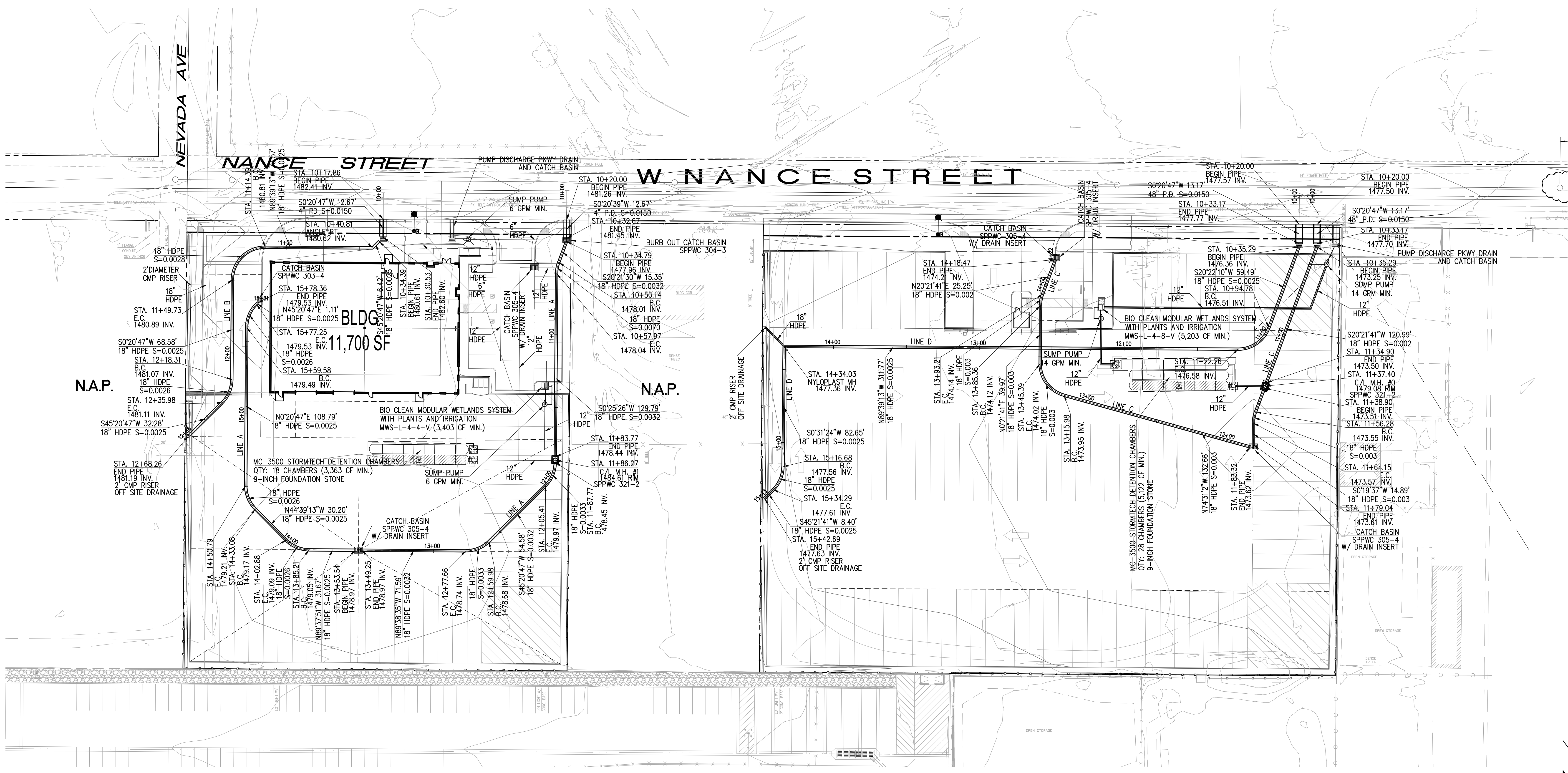

CITY OF PERRIS
PUBLIC WORKS DEPARTMENT
CONCEPTUAL STORM DRAIN PLAN
PERRIS TRAILER YARD
NANCE ST. AND NEVADA AVE.

PREPARED FOR:
LAKE CREEK INDUSTRIAL, LLC
1302 BRITANNY CROSS RD.
SANTA ANA, CA. 92705
CONTACT: BOB KUBICHEK



Designed by _____	Approved by _____	Date _____
Checked by _____	Public Works Director _____	R.C.E. XXXXX
Designed by _____		
Checked by _____		
Date _____	Sheet 3 of 4	Sheets

JNK 4130
PLST DATE: 02/22/2023

Appendix 2: Construction Plans

Grading and Drainage Plans

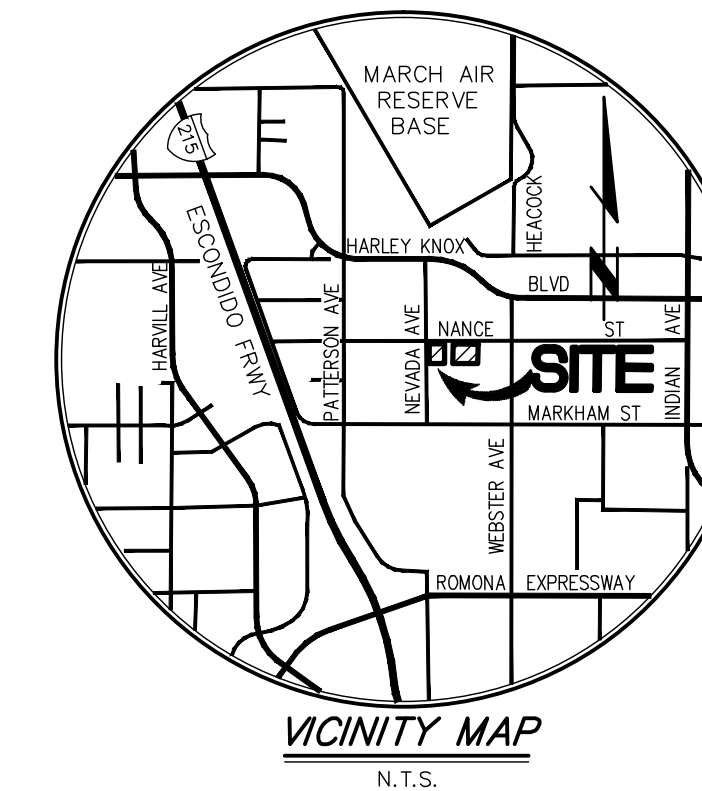

EARTHWORK BALANCE CALCULATIONS		1/25/2023
PROJECT:	LAKE CREEK INDUSTRIAL LLC - PERRIS TRAILER YARD 'WEST LOT'	
JOB#	4130	
	QUANTITY	UNITS
K. SITE AREA:	79,156	SF
L. SUBSIDENCE FACTOR:	0.1	%
M. SHRINKAGE FACTOR:	10	%
N. SITE STRIPPING FACTOR:	0.05	-
O. OVEREXCAVATION:	1,083	CY
A. CALCULATED CUT:	1,000	CY
ADDITION SLAB CUT:	-	CY
FOOTING AND UTILITY SPOILS	207	CY
RECYCLE MATERIAL	-	CY
UGS-WQMP	239	CY
TOTAL CUT: (A+B)	1,446	CY
D. CALCULATED FILL:	900	CY
E. LIGHT PAVING FILL:	-	CY
F. SUBSIDENCE: (LxK)/27=	147	CY
G. SHRINKAGE: (M/100)C=	145	CY
H. SITE STRIPPING	147	CY
I. OVEREXCAVATION SHRINKAGE	108	CY
TOTAL FILL: (D+E+F+G+H)=	1,446	CY
K. TOTAL (IMPORT) OR EXPORT:	(0)	CY
SITE ADJUSTMENT		(0.00)

EARTHWORK BALANCE CALCULATIONS		1/25/2023
PROJECT:	LAKE CREEK INDUSTRIAL LLC - PERRIS TRAILER YARD 'EAST LOT'	
JOB#	4130	
	QUANTITY	UNITS
K. SITE AREA:	118,782	SF
L. SUBSIDENCE FACTOR:	0.1	%
M. SHRINKAGE FACTOR:	10	%
N. SITE STRIPPING FACTOR:	0.05	-
O. OVEREXCAVATION:	-	CY
A. CALCULATED CUT:	1,000	CY
ADDITION SLAB CUT:	-	CY
FOOTING AND UTILITY SPOILS	186	CY
RECYCLE MATERIAL	-	CY
UGS-WQMP	353	CY
TOTAL CUT: (A+B)	1,539	CY
D. CALCULATED FILL:	755	CY
E. LIGHT PAVING FILL:	-	CY
F. SUBSIDENCE: (LxK)/27=	440	CY
G. SHRINKAGE: (M/100)C=	146	CY
H. SITE STRIPPING	198	CY
I. OVEREXCAVATION SHRINKAGE	-	CY
TOTAL FILL: (D+E+F+G+H)=	1,539	CY
K. TOTAL (IMPORT) OR EXPORT:	(0)	CY
SITE ADJUSTMENT		(0.00)

HATCH LEGEND:

- PROPOSED NANCE STREET ASPHALT PAVEMENT. (NORTH PROJECT)
- PROPOSED CONCRETE INTERSECTION APPROACH. (NORTH PROJECT)
- PROPOSED NANCE STREET ASPHALT PAVEMENT ADDITION. (SOUTH PROJECT)
- PROPOSED CONCRETE WITH DECORATIVE FINISH.

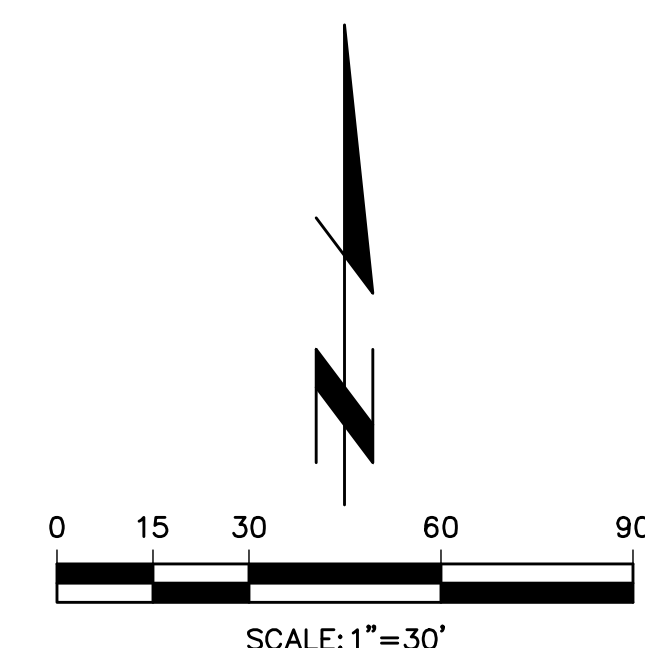

CITY OF PERRIS
PUBLIC WORKS DEPARTMENT
CONCEPTUAL GRADING PLAN
PERRIS TRAILER YARD
NANCE ST. AND NEVADA AVE.

Designed by	Approved by	Date
Checked by	Public Works Director	R.C.E. XXXXX
Designed by		
Checked by		
Date	Sheet	1 of 4

PREPARED FOR:
LAKE CREEK INDUSTRIAL, LLC
1302 BRITANNY CROSS RD.
SANTA ANA, CA. 92705
CONTACT: BOB KUBICHEK

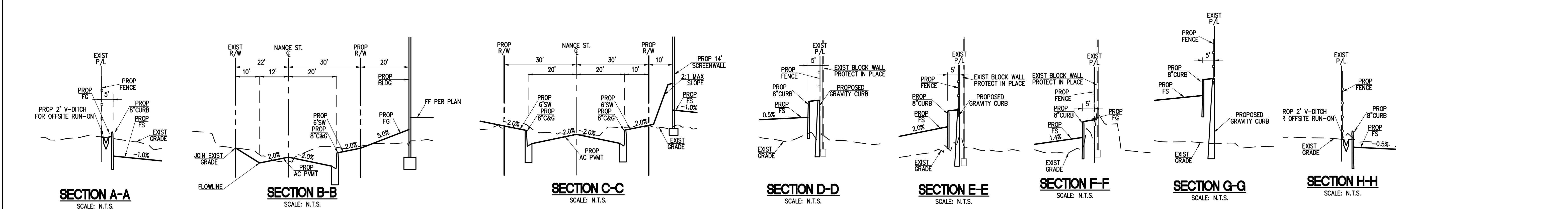
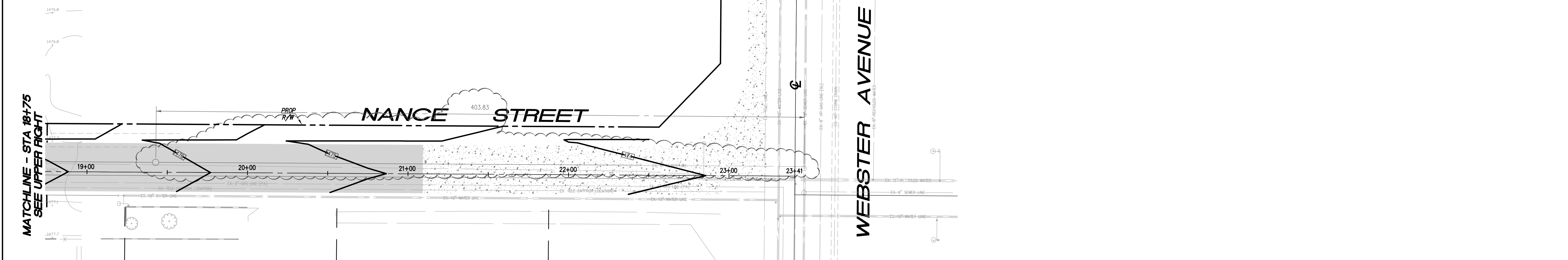
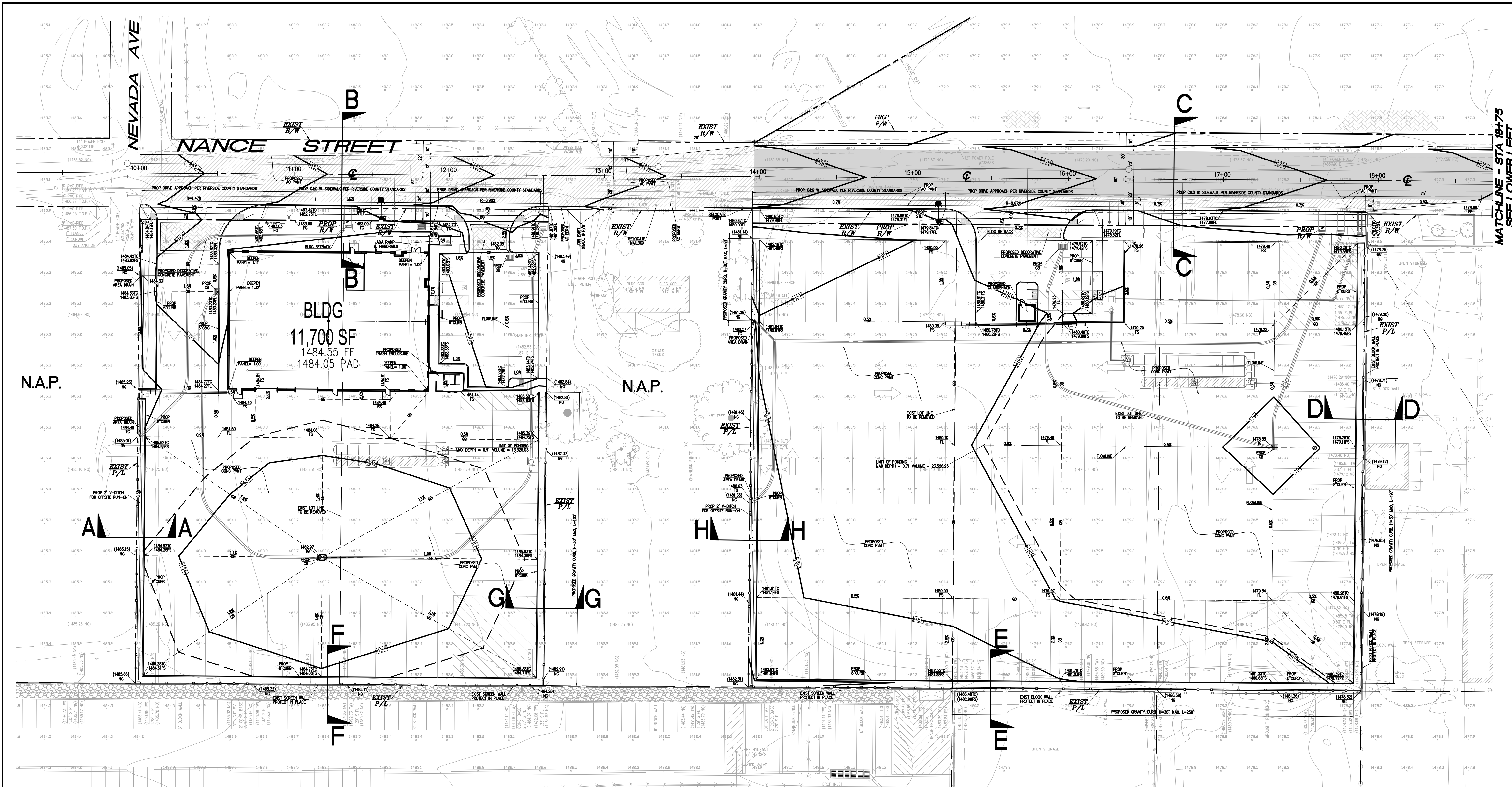

JUN 4 130
PLT DATE: 02/27/2023

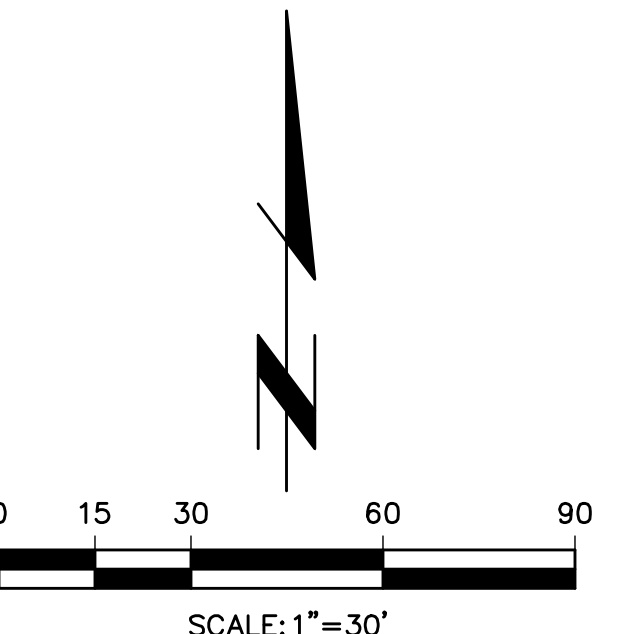
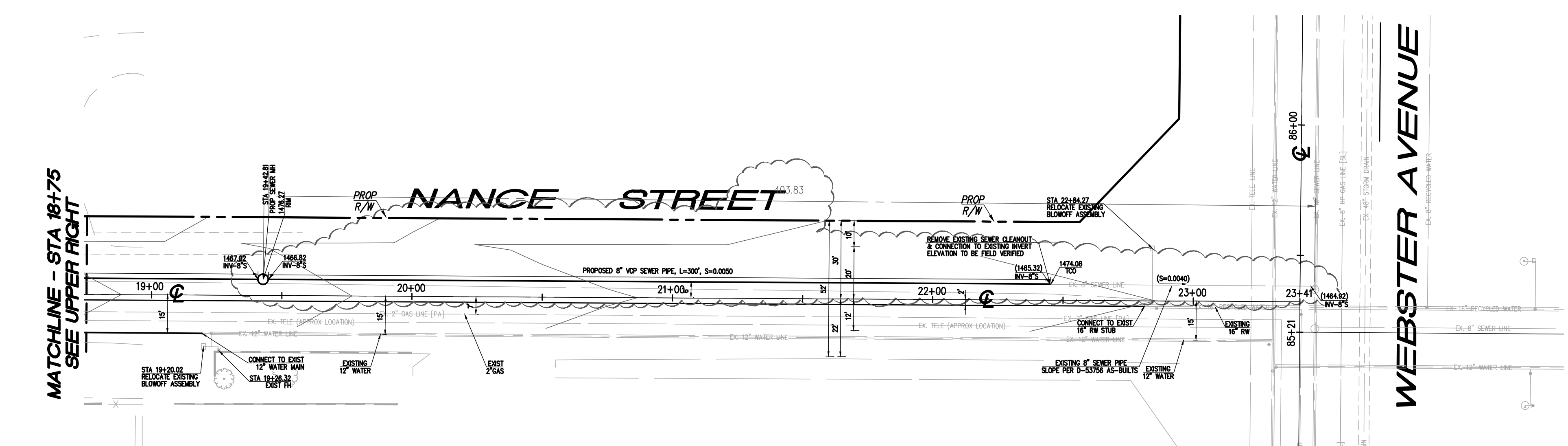
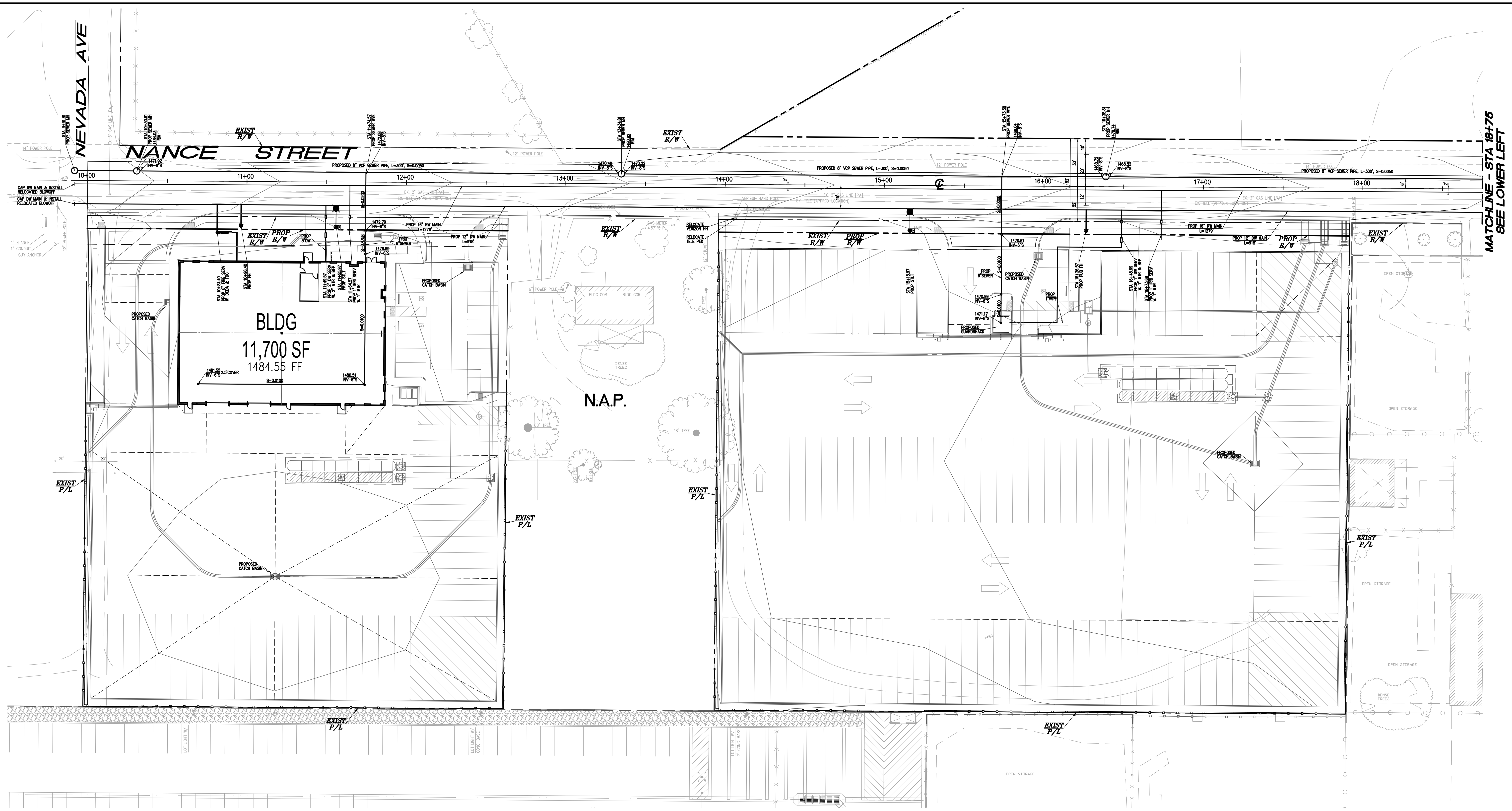
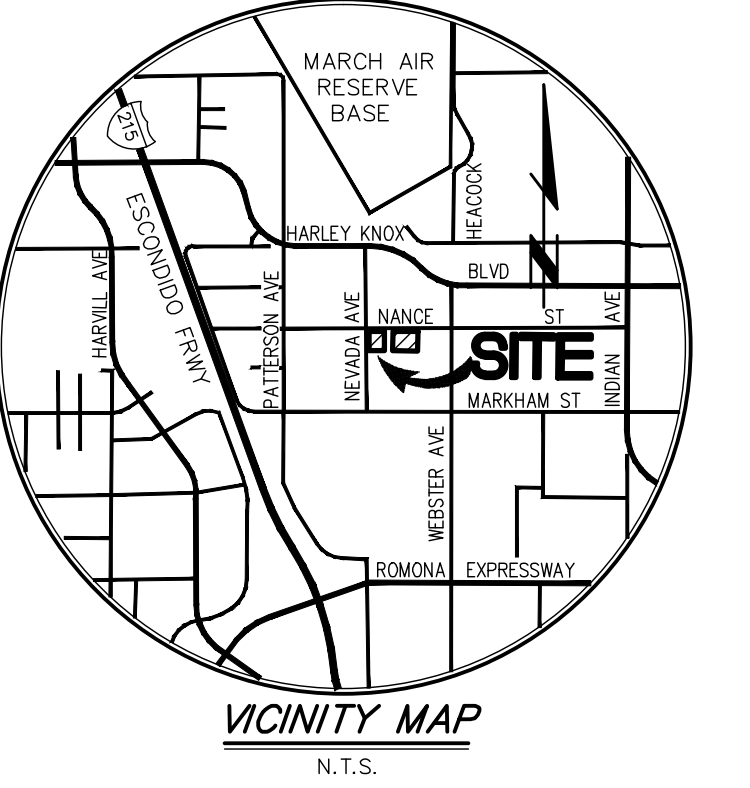

CITY OF PERRIS
PUBLIC WORKS DEPARTMENT
CONCEPTUAL UTILITY PLAN
PERRIS TRAILER YARD
NANCE ST. AND NEVADA AVE.

PREPARED FOR:
LAKE CREEK INDUSTRIAL, LLC
1302 BRITANNY CROSS RD.
SANTA ANA, CA. 92705
CONTACT: BOB KUBICHEK



Designed by _____	Approved by _____	Date _____
Checked by _____	Public Works Director _____	R.C.E. XXXXX
Designed by _____		
Date _____		
Checked by _____		
Date _____		
Sheet 2 of 4 Sheets		

JNK 4130
PLN DATE: 02/27/2023

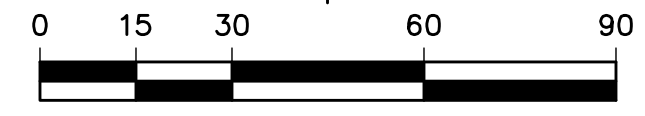
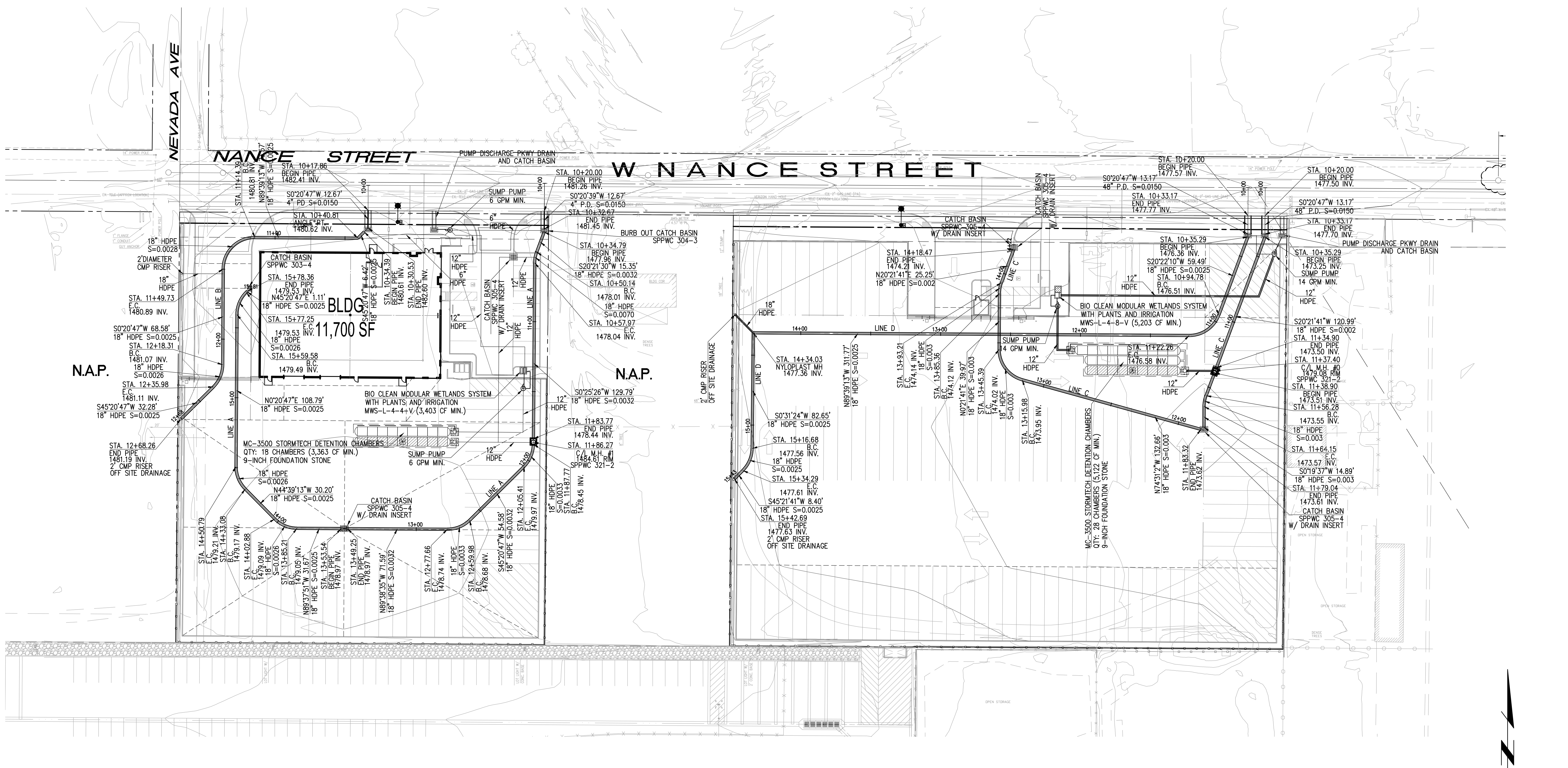

CITY OF PERRIS
PUBLIC WORKS DEPARTMENT
CONCEPTUAL STORM DRAIN PLAN
PERRIS TRAILER YARD
NANCE ST. AND NEVADA AVE.

PREPARED FOR:
LAKE CREEK INDUSTRIAL, LLC
1302 BRITANNY CROSS RD.
SANTA ANA, CA. 92705
CONTACT: BOB KUBICHEK



Designed by _____	Approved by _____	Date _____
Checked by _____	Public Works Director _____	R.C.E. XXXXX
Designed by _____		
Checked by _____		
Date _____	Sheet 3 of 4	Sheets _____

JK 4130
PLST DATE: 02/22/2023

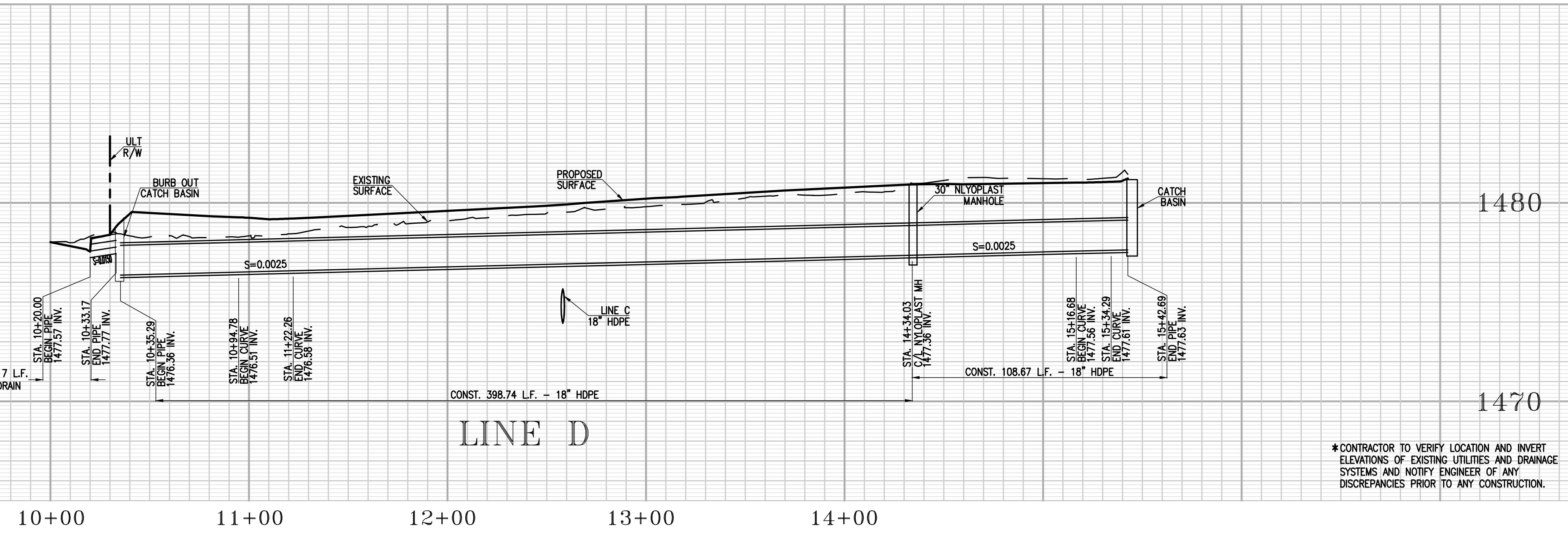
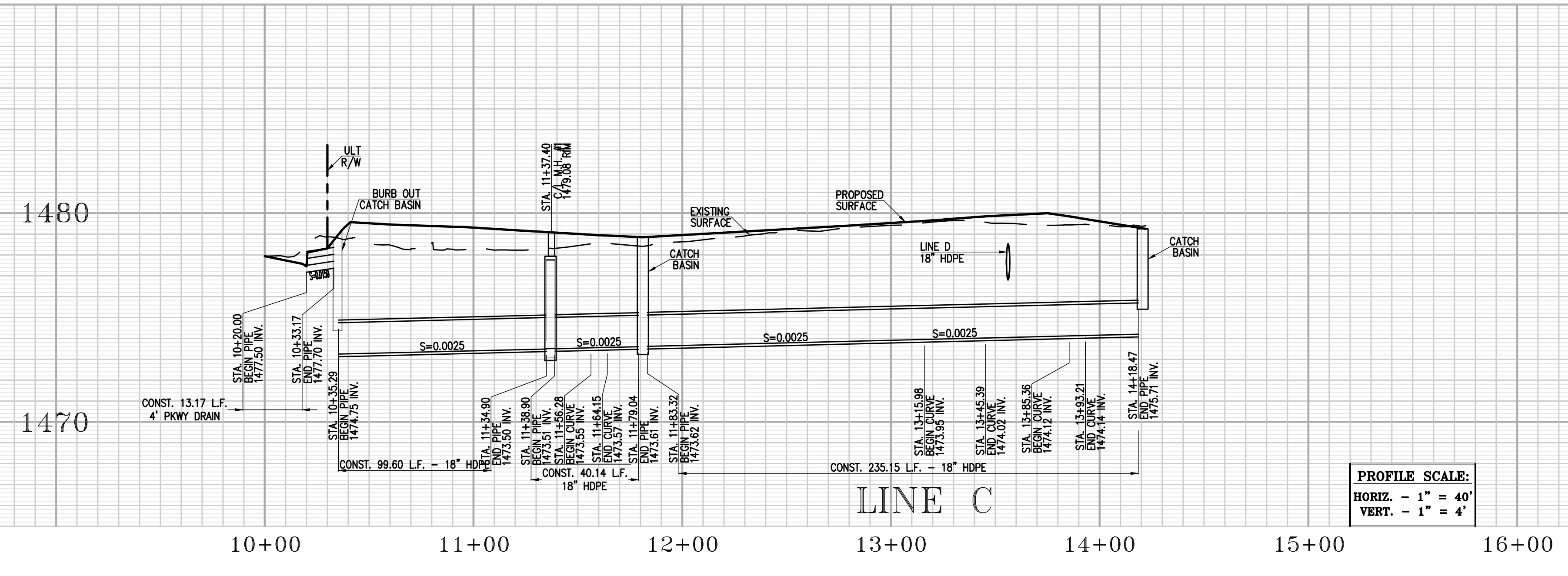
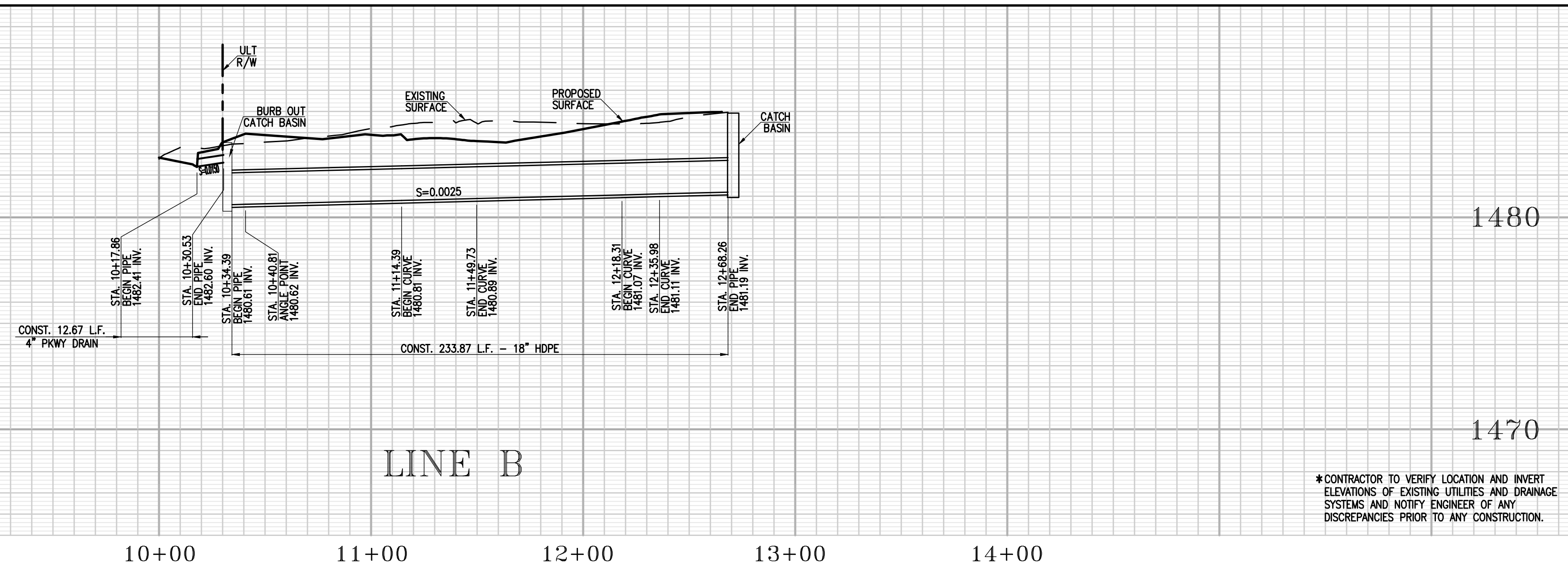
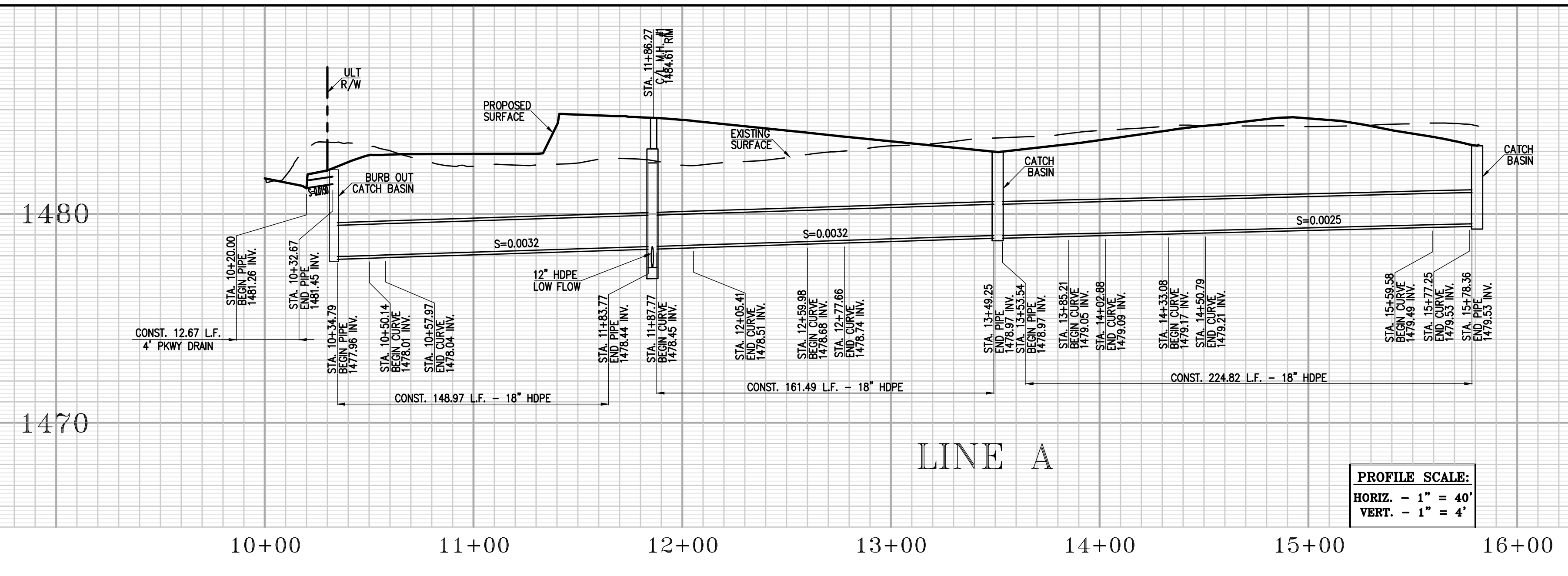

*CONTRACTOR TO VERIFY LOCATION AND INVERT ELEVATIONS OF EXISTING UTILITIES AND DRAINAGE SYSTEMS AND NOTIFY ENGINEER OF ANY DISCREPANCIES PRIOR TO ANY CONSTRUCTION.

*CONTRACTOR TO VERIFY LOCATION AND INVERT ELEVATIONS OF EXISTING UTILITIES AND DRAINAGE SYSTEMS AND NOTIFY ENGINEER OF ANY DISCREPANCIES PRIOR TO ANY CONSTRUCTION.

CITY OF PERRIS
PUBLIC WORKS DEPARTMENT
CONCEPTUAL STORM DRAIN PLAN
PERRIS TRAILER YARD
NANCE ST. AND NEVADA AVE.

PREPARED FOR
LAKE CREEK INDUSTRIAL, LLC
1302 BRITTANY CROSS RD.
SANTA ANA, CA. 92705
CONTACT: BOB KUBICHEK



Designed by _____	Approved by _____	Date _____
Checked by _____	Public Works Director _____	R.C.E. XXXXX
Designed by _____		
Checked by _____		
Date _____		
Sheet 4 of 4		Sheets

JUN. 4 130

Appendix 3: Soils Information

Geotechnical Study and Other Infiltration Testing Data



**SOUTHERN
CALIFORNIA
GEOTECHNICAL**
A California Corporation

November 23, 2022

Lake Creek Industrial, LLC
1302 Brittany Cross Road
Santa Ana, California 92705

Attention: Mr. Mike Tonkonogy
Manager

Project No.: **22G250-2**

Subject: **Results of Infiltration Testing**
Proposed Industrial Building and Trailer Storage
South Side of West Nance Street, 550± feet West of North Webster Avenue
Perris, California

Reference: Geotechnical Investigation, Proposed Industrial Building and Trailer Storage, South Side of West Nance Street, 550± feet West of North Webster Avenue, Perris, California, prepared for Lake Creek Industrial, LLC by Southern California Geotechnical, Inc. (SCG), SCG Project No. 22G250-1, dated November 21, 2022.

Mr. Tonkonogy:

In accordance with your request, we have conducted infiltration testing at the subject site. We are pleased to present this report summarizing the results of the infiltration testing and our design recommendations.

Scope of Services

The scope of services performed for this project was in general accordance with our Proposal No. 22P298R, dated October 19, 2022. The scope of services included site reconnaissance, subsurface exploration, field testing, and engineering analysis to determine the infiltration rates of the on-site soils. The infiltration testing was performed in general accordance with ASTM Test Method D-3385-03, Standard Test Method for Infiltration Rate of Soils in Field Using Double Ring Infiltrometer.

Site and Project Description

The subject site is located 530± feet west of the intersection of North Webster Avenue and West Nance Street in Perris, California. The site is bounded to the north by West Nance Street, to the east by Nevada Avenue and to the south and east by existing commercial/industrial developments. The site is also centrally sub-divided by a single-family residence that is not included in the development. The general location of the site is illustrated on the Site Location Map, enclosed as Plate 1 of this report.

The subject site consists of five (5) non-contiguous rectangular-shaped parcels, which total 4.53± acres in size. Two (2) parcels are located on the west side of the single-family residence and three (3) parcels are located on the east side. Based on aerial photographs obtained from Google Earth and observations made during the subsurface exploration, the site is currently vacant and

undeveloped. Ground surface cover appears to consist of exposed soil with sparse to moderate native grass and weed growth.

Detailed topographic information was not available at the time of this report. Based on elevations obtained from Google Earth, and visual observations made at the time of the subsurface investigation, the overall site topography is generally flat.

Proposed Development

Based on the conceptual site plan, the western portion of the site will be developed with one (1) new industrial building. The building will be 11,756± ft² in size, located in the north-central area of the site. Dock-high doors will be constructed along a portion of the south building wall. The building is expected to be surrounded by asphaltic concrete pavements in the parking and drive areas, Portland cement concrete pavements in the truck court areas, and limited areas of concrete flatwork and landscape planters throughout. The eastern portion of the site will be developed as a truck and trailer parking lot with a guard shack.

Although not depicted on the site plan, we assume the site will utilize on-site stormwater disposal. Based on our experience with nearby projects, we assume that the systems will consist of belowgrade chambers extending to depths of 8 to 10± feet below ground surface. It is recommended that the project civil engineer be contacted to confirm the depth and location of the proposed infiltration systems prior to infiltration testing.

Concurrent Study

SCG concurrently conducted a geotechnical investigation at the subject site, which is referenced above. As part of this study, nine (9) borings were advanced to depths of 5 to 20± feet below existing site grades. Artificial fill soils were encountered at the ground surface at all of the boring locations, with the exception of Boring Nos. B-2 and B-7, extending to depths of 2½ to 4½± feet below the existing site grades. The fill soils generally consist of medium dense to dense silty sands with varying clay content. Boring No. B-6 encountered a stratum consisting of hard sandy clays at the ground surface, extending to a depth of 2½± feet. The fill soils possess a mottled and disturbed appearance resulting in their classification as artificial fill. Native younger alluvium was encountered beneath the artificial fill soils at Boring No. B-9, extending to a depth of 8± feet below the existing site grades. The younger alluvium generally consists of medium dense clayey sands. Native older alluvium was encountered at the ground surface at Boring Nos. B-2 and B-7, beneath the younger alluvium at Boring Nos. B-9, and beneath the artificial fill soils at the remaining boring locations, extending to at least the maximum depth explored of 20± feet below the existing site grades. The older alluvium generally consists of medium dense to very dense clayey sands with varying silt content, medium dense to very dense silty sands and sandy silts with varying clay content, and very stiff to hard sandy clays with varying silt content. Boring Nos. B-4 and B-9 encountered a stratum consisting of hard clayey silts at a depth of 17 to 20± feet.

Groundwater

Free water was not encountered during the drilling of any of the borings. Based on the moisture content of the recovered soil samples and the lack of free water in the borings, the static

groundwater table is at a depth greater than the maximum explored depth of 12± feet below existing site grades for this project.

Recent water level data was obtained from the California Department of Water Resources website, <http://www.water.ca.gov/waterdatalibrary/>. Two (2) monitoring wells on record (identified as Local Well Names: EMWD12471 and EMWD12474) are located within 650± feet from the center of the proposed building. Water level readings within these monitoring wells indicate a high groundwater level of 65± feet below the ground surface in March 2022.

Subsurface Exploration

Scope of Exploration

The subsurface exploration for the infiltration testing consisted of four (4) backhoe-excavated trenches, extending to depths of 8 to 12± feet below existing site grades. The trenches were logged during excavation by a member of our staff. The approximate locations of the infiltration trenches (identified as I-1 through I-4) are indicated on the Infiltration Test Location Plans, enclosed as Plate 2 of this report.

Geotechnical Conditions

Artificial fill soils were encountered at the ground surface at all of the infiltration trenches, extending 1 to 2± feet below existing site grades. The fill soils extend to depths of 1 to 2± feet below the existing site grades. The fill soils generally consist of loose to medium dense fine sandy silts to silty fine sands with trace fine root fibers and trace clays. These materials possess a disturbed appearance, resulting in their classification as artificial fill. Native alluvium was encountered below the fill soils at all of the boring locations, extending to at least the maximum depth explored of 12± feet below existing site grades. The alluvium generally consists of dense to very dense silty fine to medium sands with trace clay content, trace calcareous veins, and slightly cemented. The Trench Logs, which illustrate the conditions encountered at the infiltration test locations, are presented in this report.

Infiltration Testing

We understand that the results of the testing will be used to prepare a preliminary design for the storm water infiltration system that will be used at the subject site. As previously mentioned, the infiltration testing was performed in general accordance with ASTM Test Method D-3385-03, Standard Test Method for Infiltration Rate of Soils in Field Using Double Ring Infiltrometer.

Two stainless steel infiltration rings were used for the infiltration testing. The outer infiltration ring is 2 feet in diameter and 20 inches in height. The inner infiltration ring is 1 foot in diameter and 20 inches in height. At the test locations, the outer ring was driven 3± inches into the soil at the base of each trench. The inner ring was centered inside the outer ring and subsequently driven 3± inches into the soil at the base of the trench. The rings were driven into the soil using a ten-pound sledge hammer. The soil surrounding the wall of the infiltration rings was only slightly disturbed during the driving process.

Infiltration Testing Procedure

Infiltration testing was performed at all of the trench locations. The infiltration testing consisted of filling the inner ring and the annular space (the space between the inner and outer rings) with water, approximately 3 to 4 inches above the soil. To prevent the flow of water from one ring to the other, the water level in both the inner ring and the annular space between the rings was maintained using constant-head float valves. The volume of water that was added to maintain a constant head in the inner ring and the annular space during each time interval was determined and recorded. A cap was placed over the rings to minimize the evaporation of water during the tests.

The schedule for readings was determined based on the observed soil type at the base of each backhoe-excavated trench. Based on the existing soils at the trench locations, the volumetric measurements were made at 15-minute increments. The water volume measurements are presented on the spreadsheets enclosed with this report. The infiltration rates for each of the timed intervals are also tabulated on these spreadsheets.

The infiltration rates for the infiltration tests are calculated in centimeters per hour and then converted to inches per hour. The rates are summarized below:

<u>Infiltration Test No.</u>	<u>Depth Test (feet)</u>	<u>Soil Description</u>	<u>Measured Infiltration Rate (inches/hour)</u>
I-1	8	Silty fine to medium Sand, trace coarse Sand, trace to little Clay	0.7
I-2	12	Silty fine to medium Sand, little coarse Sand, trace Clay	0.1
I-3	8	Silty fine to medium Sand, trace coarse Sand, trace Clay	0.0
I-4	11	Silty fine to medium Sand, little Clay	0.0

Design Recommendations

Four (4) infiltration tests were performed at the subject site. As noted above, the calculated infiltration rates at the infiltration test locations range from 0.0 to 0.7 inches per hour. The major factors affecting the lack of infiltration at these locations is the presence of very dense alluvium and higher fines content. **Due to the poor infiltration characteristics of the on-site native soils at the tested depths, infiltration is not recommended.**

Although infiltration is not considered feasible at the site, the client may desire to use storm water disposal systems that do not rely on infiltration at this site. The design of storm water disposal systems should be performed by the project civil engineer, in accordance with the City of Perris and/or County of Riverside guidelines. It is recommended any such systems be designed and constructed to facilitate removal of silt and clay, or other deleterious materials from any water that may enter the system. The presence of such materials would decrease the flow rates through the system. It should be noted that the recommended infiltration rates are based on infiltration

testing at four (4) discrete locations and that the overall infiltration rates of the proposed infiltration systems could vary considerably.

Infiltration Rate Considerations

The infiltration rates presented herein was determined in accordance with the Riverside County guidelines and are considered valid only for the time and place of the actual test. Varying subsurface conditions will exist in other areas of the site, which could alter the recommended infiltration rates presented above. The infiltration rates will decline over time between maintenance cycles as silt or clay particles accumulate on the BMP surface. The infiltration rate is highly dependent upon a number of factors, including density, silt and clay content, grain size distribution throughout the range of particle sizes, and particle shape. Small changes in these factors can cause large changes in the infiltration rates.

Infiltration rates are based on unsaturated flow. As water is introduced into soils by infiltration, the soils become saturated and the wetting front advances from the unsaturated zone to the saturated zone. Once the soils become saturated, infiltration rates become zero, and water can only move through soils by hydraulic conductivity at a rate determined by pressure head and soil permeability. Changes in soil moisture content will affect the infiltration rate. Infiltration rates should be expected to decrease until the soils become saturated. Soil permeability values will then govern groundwater movement. Permeability values may be on the order of 10 to 20 times less than infiltration rates. The system designer should incorporate adequate factors of safety and allow for overflow design into appropriate traditional storm drain systems, which would transport storm water off-site.

Construction Considerations

The infiltration rates presented in this report are specific to the tested locations and tested depths. Infiltration rates can be significantly reduced if the soils are exposed to excessive disturbance or compaction during construction. Compaction of the soils at the bottom of the infiltration system can significantly reduce the infiltration ability of the basins. Therefore, the subgrade soils within proposed infiltration system areas should not be over-excavated, undercut or compacted in any significant manner. **It is recommended that a note to this effect be added to the project plans and/or specifications.**

We recommend that a representative from the geotechnical engineer be on-site during the construction of the proposed infiltration systems to identify the soil classification at the base of each system. The infiltration rate of the system will likely vary significantly if the composition of the soil located beneath the system is not consistent with the tested soils.

We recommend that scrapers and other rubber-tired heavy equipment not be operated on the basin bottom, or at levels lower than 2 feet above the bottom of the system, particularly within basins. As such, the bottom 24 inches of the infiltration systems should be excavated with non-rubber-tired equipment, such as excavators.

Chamber Maintenance

The proposed project may include below-grade infiltration chambers. Water flowing into these chambers will carry some level of sediment. This layer has the potential to significantly reduce

the infiltration rate of the basin subgrade soils. Therefore, a formal chamber maintenance program should be established to ensure that these silt and clay deposits are removed from the chamber on a regular basis.

Location of Infiltration Systems

The use of on-site storm water infiltration systems carries a risk of creating adverse geotechnical conditions. Increasing the moisture content of the soil can cause the soil to lose internal shear strength and increase its compressibility, resulting in a change in the designed engineering properties. Overlying structures and pavements in the infiltration area could potentially be damaged due to saturation of the subgrade soils. **The proposed infiltration systems for this site should be located at least 25 feet away from any structures, including retaining walls.** Even with this provision of locating the infiltration system at least 25 feet from the building(s), it is possible that infiltrating water into the subsurface soils could have an adverse effect on the proposed or existing structures. It should also be noted that utility trenches which happen to collect storm water can also serve as conduits to transmit storm water toward the structure, depending on the slope of the utility trench. Therefore, consideration should also be given to the proposed locations of underground utilities which may pass near the proposed infiltration system.

The infiltration system designer should also give special consideration to the effect that the proposed infiltration systems may have on nearby subterranean structures, open excavations, or descending slopes. In particular, infiltration systems should not be located near the crest of descending slopes, particularly where the slopes are comprised of granular soils. Such systems will require specialized design and analysis to evaluate the potential for slope instability, piping failures and other phenomena that typically apply to earthen dam design. This type of analysis is beyond the scope of this infiltration test report, but these factors should be considered by the infiltration system designer when locating the infiltration systems.

General Comments

This report has been prepared as an instrument of service for use by the client in order to aid in the evaluation of this property and to assist the architects and engineers in the design and preparation of the project plans and specifications. This report may be provided to the contractor(s) and other design consultants to disclose information relative to the project. However, this report is not intended to be utilized as a specification in and of itself, without appropriate interpretation by the project architect, structural engineer, and/or civil engineer. The design of the proposed storm water infiltration system is the responsibility of the civil engineer. The role of the geotechnical engineer is limited to determination of infiltration rate only. By using the design infiltration rate contained herein, the civil engineer agrees to indemnify, defend, and hold harmless the geotechnical engineer for all aspects of the design and performance of the proposed storm water infiltration system. The reproduction and distribution of this report must be authorized by the client and Southern California Geotechnical, Inc. Furthermore, any reliance **on this report by an unauthorized third party is at such party's sole risk, and we accept no responsibility for damage or loss which may occur.**

The analysis of this site was based on a subsurface profile interpolated from limited discrete soil samples. While the materials encountered in the project area are considered to be representative

of the total area, some variations should be expected between boring locations and testing depths. If the conditions encountered during construction vary significantly from those detailed herein, we should be contacted immediately to determine if the conditions alter the recommendations contained herein.

This report has been based on assumed or provided characteristics of the proposed development. It is recommended that the owner, client, architect, structural engineer, and civil engineer carefully review these assumptions to ensure that they are consistent with the characteristics of the proposed development. If discrepancies exist, they should be brought to our attention to verify that they do not affect the conclusions and recommendations contained herein. We also recommend that the project plans and specifications be submitted to our office for review to verify that our recommendations have been correctly interpreted. The analysis, conclusions, and recommendations contained within this report have been promulgated in accordance with generally accepted professional geotechnical engineering practice. No other warranty is implied or expressed.

Closure

We sincerely appreciate the opportunity to be of service on this project. We look forward to providing additional consulting services during the course of the project. If we may be of further assistance in any manner, please contact our office.

Respectfully Submitted,
SOUTHERN CALIFORNIA GEOTECHNICAL, INC.



Joseph Hernandez
Staff Geologist

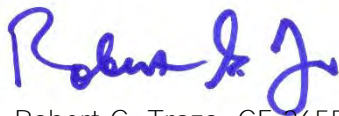

Robert G. Trazo, GE 2655
Principal Engineer



Distribution: (1) Addressee

Enclosures: Plate 1 - Site Location Map
Plate 2 - Infiltration Test Location Plan
Trench Log Legend and Logs (6 pages)
Infiltration Test Results Spreadsheets (4 pages)
Grain Size Distribution Graphs (4 pages)

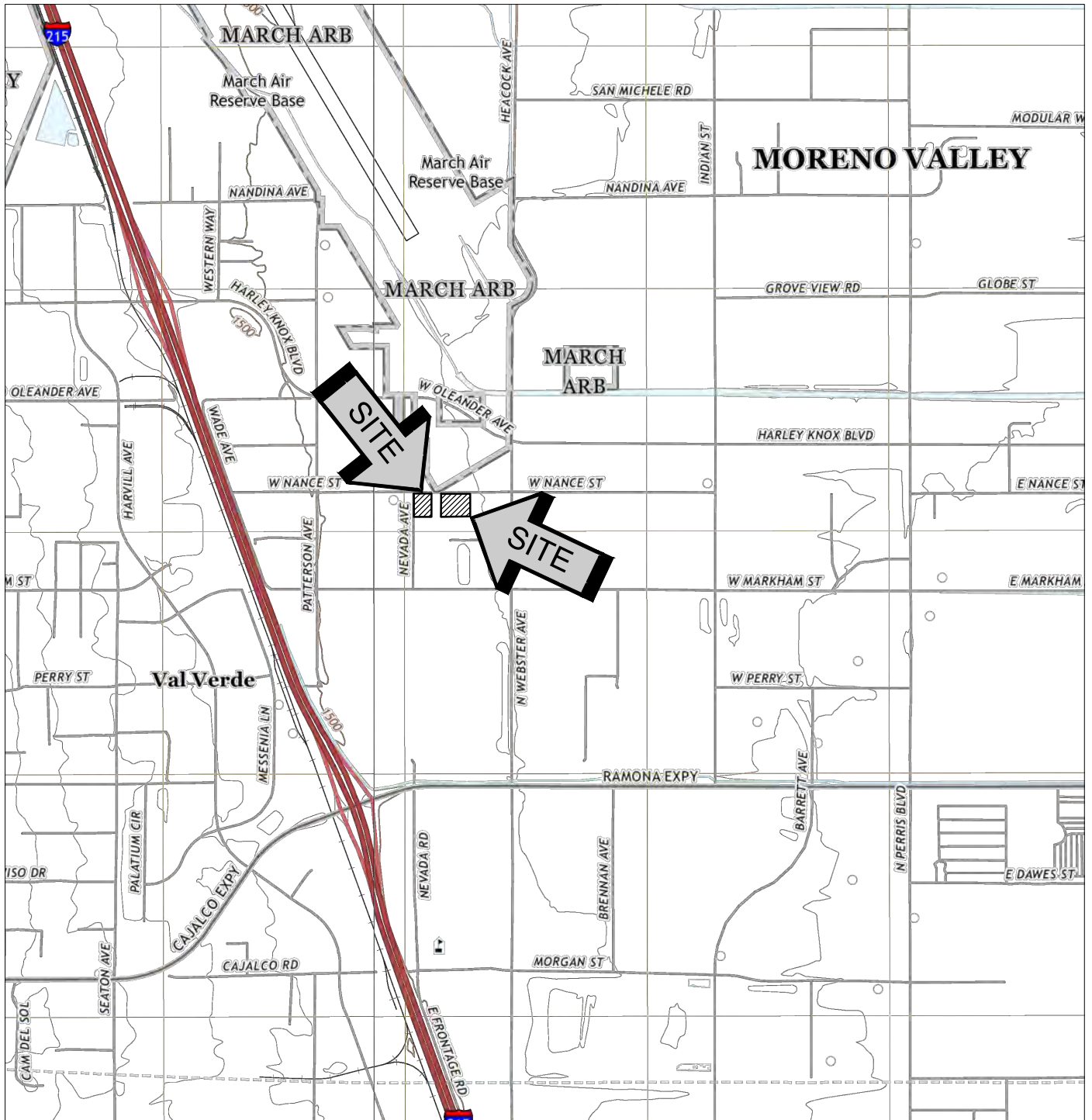



SOURCE: USGS TOPOGRAPHIC MAPS OF THE STEELE PEAK QUADRANGLE AND THE PERRIS QUADRANGLE, RIVERSIDE COUNTY, CALIFORNIA, 2021.

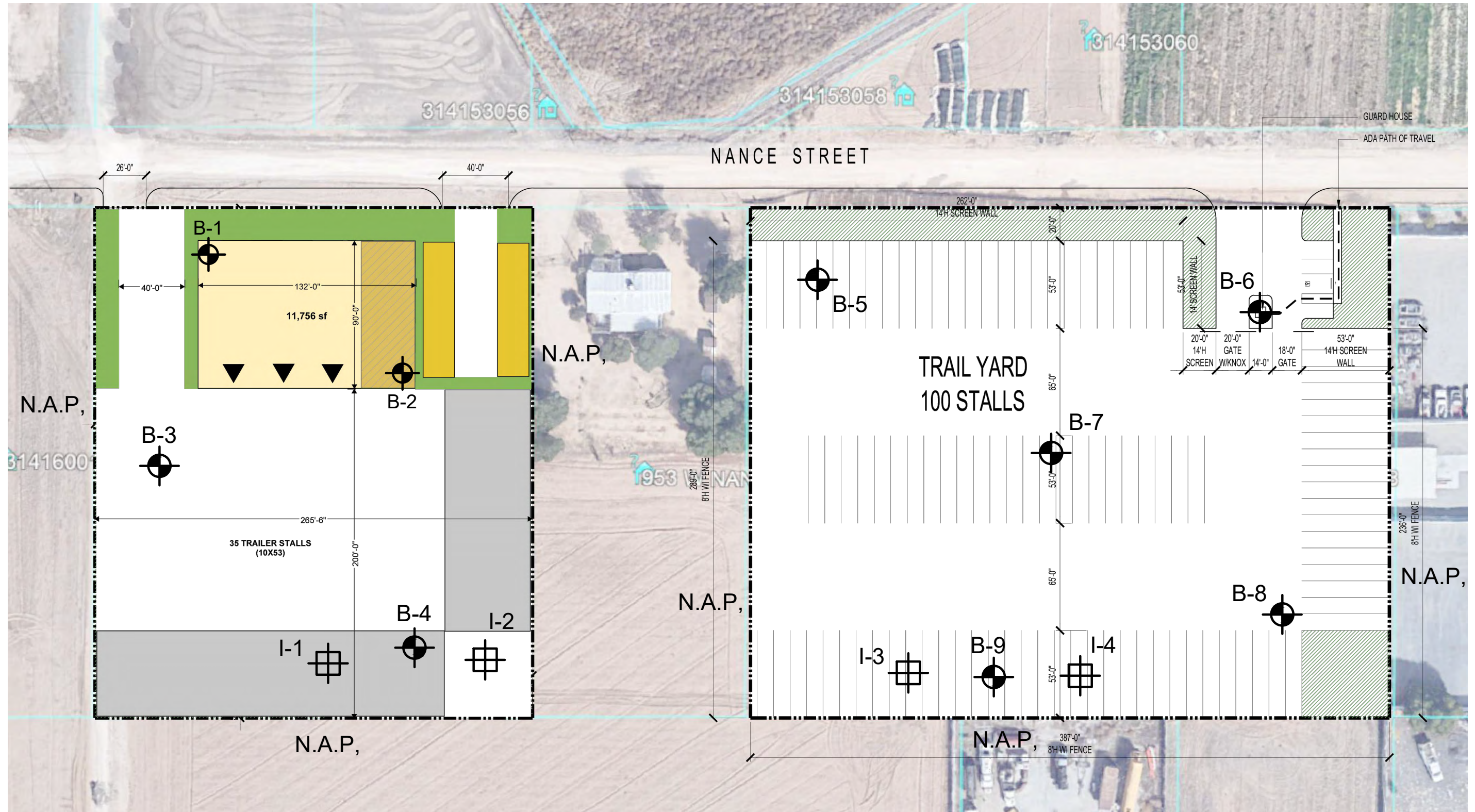

SITE LOCATION MAP	
PROPOSED INDUSTRIAL BUILDING AND TRAILER STORAGE	
PERRIS, CALIFORNIA	
SCALE: 1" = 2000'	 SOUTHERN CALIFORNIA GEOTECHNICAL
DRAWN: JLL	
CHKD: RGT	
SCG PROJECT 22G250-2	
PLATE 1	



GEOTECHNICAL LEGEND



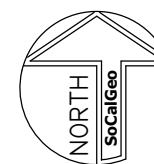



-  APPROXIMATE INFILTRATION TEST LOCATION
-  APPROXIMATE BORING LOCATION FROM CONCURRENT STUDY (SCG PROJECT NO. 22G250-1)

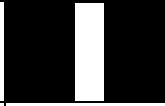

NOTE: CONCEPTUAL SITE PLAN (VERSION 3) PROVIDED BY THE CLIENT.

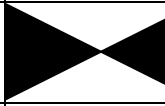
INFILTRATION TEST LOCATION PLAN	
PROPOSED INDUSTRIAL BUILDING AND TRAILER STORAGE	
PERRIS, CALIFORNIA	
SCALE: 1" = 60'	
DRAWN: JLL	
CHKD: RGT	
SCG PROJECT 22G250-2	
PLATE 2	SOUTHERN CALIFORNIA GEOTECHNICAL

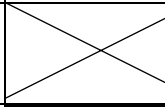
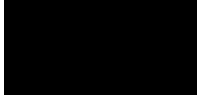
TRENCH LOG LEGEND

SAMPLE TYPE	GRAPHICAL SYMBOL	SAMPLE DESCRIPTION
AUGER		SAMPLE COLLECTED FROM AUGER CUTTINGS, NO FIELD MEASUREMENT OF SOIL STRENGTH. (DISTURBED)
CORE		ROCK CORE SAMPLE: TYPICALLY TAKEN WITH A DIAMOND-TIPPED CORE BARREL. TYPICALLY USED ONLY IN HIGHLY CONSOLIDATED BEDROCK.
GRAB		SOIL SAMPLE TAKEN WITH NO SPECIALIZED EQUIPMENT, SUCH AS FROM A STOCKPILE OR THE GROUND SURFACE. (DISTURBED)
CS		CALIFORNIA SAMPLER: 2-1/2 INCH I.D. SPLIT BARREL SAMPLER, LINED WITH 1-INCH HIGH BRASS RINGS. DRIVEN WITH SPT HAMMER. (RELATIVELY UNDISTURBED)
NSR		NO RECOVERY: THE SAMPLING ATTEMPT DID NOT RESULT IN RECOVERY OF ANY SIGNIFICANT SOIL OR ROCK MATERIAL.
SPT		STANDARD PENETRATION TEST: SAMPLER IS A 1.4 INCH INSIDE DIAMETER SPLIT BARREL, DRIVEN 18 INCHES WITH THE SPT HAMMER. (DISTURBED)
SH		SHELBY TUBE: TAKEN WITH A THIN WALL SAMPLE TUBE, PUSHED INTO THE SOIL AND THEN EXTRACTED. (UNDISTURBED)
VANE		VANE SHEAR TEST: SOIL STRENGTH OBTAINED USING A 4 BLADED SHEAR DEVICE. TYPICALLY USED IN SOFT CLAYS-NO SAMPLE RECOVERED.

COLUMN DESCRIPTIONS

DEPTH:

Distance in feet below the ground surface.

SAMPLE:

Sample Type as depicted above.

BLOW COUNT:

Number of blows required to advance the sampler 12 inches using a 140 lb hammer with a 30-inch drop. **50/3"** indicates penetration refusal (>50 blows) at 3 inches. WH indicates that the weight of the hammer was sufficient to push the sampler 6 inches or more.

POCKET PEN.:

Approximate shear strength of a cohesive soil sample as measured by pocket penetrometer.

GRAPHIC LOG:

Graphic Soil Symbol as depicted on the following page.

DRY DENSITY:

Dry density of an undisturbed or relatively undisturbed sample in lbs/ft³.

MOISTURE CONTENT:

Moisture content of a soil sample, expressed as a percentage of the dry weight.

LIQUID LIMIT:

The moisture content above which a soil behaves as a liquid.

PLASTIC LIMIT:

The moisture content above which a soil behaves as a plastic.

PASSING #200 SIEVE:

The percentage of the sample finer than the #200 standard sieve.

UNCONFINED SHEAR:

The shear strength of a cohesive soil sample, as measured in the unconfined state.

SOIL CLASSIFICATION CHART

MAJOR DIVISIONS			SYMBOLS		TYPICAL DESCRIPTIONS	
			GRAPH	LETTER		
<p>COARSE GRAINED SOILS</p> <p>MORE THAN 50% OF MATERIAL IS LARGER THAN NO. 200 SIEVE SIZE</p>	<p>GRAVEL AND GRAVELLY SOILS</p>	<p>CLEAN GRAVELS</p> <p>(LITTLE OR NO FINES)</p>		GW	WELL-GRADED GRAVELS, GRAVEL - SAND MIXTURES, LITTLE OR NO FINES	
		<p>GRAVELS WITH FINES</p> <p>(APPRECIABLE AMOUNT OF FINES)</p>		GP	POORLY-GRADED GRAVELS, GRAVEL - SAND MIXTURES, LITTLE OR NO FINES	
		<p>MORE THAN 50% OF COARSE FRACTION RETAINED ON NO. 4 SIEVE</p>		GM	SILTY GRAVELS, GRAVEL - SAND - SILT MIXTURES	
		<p>(APPRECIABLE AMOUNT OF FINES)</p>		GC	CLAYEY GRAVELS, GRAVEL - SAND - CLAY MIXTURES	
	<p>SAND AND SANDY SOILS</p>	<p>CLEAN SANDS</p> <p>(LITTLE OR NO FINES)</p>		SW	WELL-GRADED SANDS, GRAVELLY SANDS, LITTLE OR NO FINES	
				SP	POORLY-GRADED SANDS, GRAVELLY SAND, LITTLE OR NO FINES	
		<p>MORE THAN 50% OF COARSE FRACTION PASSING ON NO. 4 SIEVE</p>	<p>SANDS WITH FINES</p> <p>(APPRECIABLE AMOUNT OF FINES)</p>		SM	SILTY SANDS, SAND - SILT MIXTURES
					SC	CLAYEY SANDS, SAND - CLAY MIXTURES
			<p>SILTS AND CLAYS</p> <p>LIQUID LIMIT LESS THAN 50</p>		ML	INORGANIC SILTS AND VERY FINE SANDS, ROCK FLOUR, SILTY OR CLAYEY FINE SANDS OR CLAYEY SILTS WITH SLIGHT PLASTICITY
					CL	INORGANIC CLAYS OF LOW TO MEDIUM PLASTICITY, GRAVELLY CLAYS, SANDY CLAYS, SILTY CLAYS, LEAN CLAYS
<p>MORE THAN 50% OF MATERIAL IS SMALLER THAN NO. 200 SIEVE SIZE</p>	<p>SILTS AND CLAYS</p> <p>LIQUID LIMIT GREATER THAN 50</p>		OL	ORGANIC SILTS AND ORGANIC SILTY CLAYS OF LOW PLASTICITY		
			MH	INORGANIC SILTS, MICACEOUS OR DIATOMACEOUS FINE SAND OR SILTY SOILS		
			CH	INORGANIC CLAYS OF HIGH PLASTICITY		
<p>HIGHLY ORGANIC SOILS</p>				OH	ORGANIC CLAYS OF MEDIUM TO HIGH PLASTICITY, ORGANIC SILTS	
<p>HIGHLY ORGANIC SOILS</p>				PT	PEAT, HUMUS, SWAMP SOILS WITH HIGH ORGANIC CONTENTS	

NOTE: DUAL SYMBOLS ARE USED TO INDICATE BORDERLINE SOIL CLASSIFICATIONS



JOB NO.: 22G250-2	EXCAVATION DATE: 11/3/22	WATER DEPTH: Dry
PROJECT: Prop. Industrial Building & Trailer Storage	EXCAVATION METHOD: Backhoe	CAVE DEPTH: ---
LOCATION: Perris, California	LOGGED BY: Caleb Brackett	READING TAKEN: At Completion

FIELD RESULTS					DESCRIPTION	LABORATORY RESULTS						COMMENTS
DEPTH (FEET)	SAMPLE	BLOW COUNT	POCKET PEN. (TSF)	GRAPHIC LOG		DRY DENSITY (PCF)	MOISTURE CONTENT (%)	LIQUID LIMIT	PLASTIC LIMIT	PASSING #200 SIEVE (%)	ORGANIC CONTENT (%)	
5					<p style="text-align: center;">SURFACE ELEVATION: --- MSL</p> <p>FILL: Light Brown fine Sandy Silt, trace fine root fibers, loose-dry</p> <p>ALLUVIUM: Brown Silty fine to medium Sand, trace coarse Sand, trace to little Clay, trace to little Calcareous nodules and veining, slightly cemented, slightly porous, dense to very dense-damp</p>		5		41			
					Trench Terminated at 8'							

TBL_22G250-2.GPJ_SOCALGEO.GDT 11/23/22



JOB NO.: 22G250-2 EXCAVATION DATE: 11/3/22 WATER DEPTH: Dry
 PROJECT: Prop. Industrial Building & Trailer Storage EXCAVATION METHOD: Backhoe CAVE DEPTH: ---
 LOCATION: Perris, California LOGGED BY: Caleb Brackett READING TAKEN: At Completion

FIELD RESULTS					DESCRIPTION	LABORATORY RESULTS						COMMENTS
DEPTH (FEET)	SAMPLE	BLOW COUNT	POCKET PEN. (TSF)	GRAPHIC LOG		DRY DENSITY (PCF)	MOISTURE CONTENT (%)	LIQUID LIMIT	PLASTIC LIMIT	PASSING #200 SIEVE (%)	ORGANIC CONTENT (%)	
					SURFACE ELEVATION: --- MSL							
					FILL: Light Brown fine Sandy Silt, trace fine root fibers, loose-dry							
5					OLDER ALLUVIUM: Brown Silty fine to medium Sand, little coarse Sand, trace Clay, trace Calcareous nodules and veining, slightly cemented, slightly porous, dense to very dense-damp to moist		7			34		
10												
					Boring Terminated at 12'							

TBL_22G250-2.GPJ_SOCALGEO.GDT_11/23/22



JOB NO.: 22G250-2 EXCAVATION DATE: 11/1/22 WATER DEPTH: Dry
 PROJECT: Prop. Industrial Building & Trailer Storage EXCAVATION METHOD: Backhoe CAVE DEPTH: ---
 LOCATION: Perris, California LOGGED BY: Caleb Brackett READING TAKEN: At Completion

FIELD RESULTS					DESCRIPTION	LABORATORY RESULTS						COMMENTS
DEPTH (FEET)	SAMPLE	BLOW COUNT	POCKET PEN. (TSF)	GRAPHIC LOG		DRY DENSITY (PCF)	MOISTURE CONTENT (%)	LIQUID LIMIT	PLASTIC LIMIT	PASSING #200 SIEVE (%)	ORGANIC CONTENT (%)	
					<p style="text-align: center;">SURFACE ELEVATION: --- MSL</p> <p>FILL: Brown fine Sandy Silt, trace fine root fibers, trash trash debris, loose-dry</p> <p>FILL: Brown Silty fine Sand, trace medium Sand, trace Clay, medium dense-damp</p> <p>OLDER ALLUVIUM: Brown Silty fine to coarse Sand, trace Clay, dense-damp</p> <p>OLDER ALLUVIUM: Brown Silty fine to medium Sand, trace coarse Sand, trace Clay, slightly cemented, slightly porous, very dense-damp</p>							
5							6		40			
					Boring Terminated at 8'							

TBL_22G250-2.GPJ_SOCALGEO.GDT 11/23/22



JOB NO.: 22G250-2 EXCAVATION DATE: 11/1/22 WATER DEPTH: Dry
 PROJECT: Prop. Industrial Building & Trailer Storage EXCAVATION METHOD: Backhoe CAVE DEPTH: ---
 LOCATION: Perris, California LOGGED BY: Caleb Brackett READING TAKEN: At Completion

FIELD RESULTS					DESCRIPTION	LABORATORY RESULTS						COMMENTS
DEPTH (FEET)	SAMPLE	BLOW COUNT	POCKET PEN. (TSF)	GRAPHIC LOG		DRY DENSITY (PCF)	MOISTURE CONTENT (%)	LIQUID LIMIT	PLASTIC LIMIT	PASSING #200 SIEVE (%)	ORGANIC CONTENT (%)	
					<p style="text-align: center;">SURFACE ELEVATION: --- MSL</p> <p>FILL: Brown fine Sandy Silt, trace fine root fibers, trace trash debris, loose to medium dense-dry</p> <p>OLDER ALLUVIUM: Brown Silty fine to medium Sand, little Clay, slightly cemented, slightly porous, trace Calcarous nodules and veining, very dense-damp to moist</p>							
5												
10							7			42		
					Boring Terminated at 11'							

TBL_22G250-2.GPJ_SOCALGEO.GDT_11/23/22

INFILTRATION CALCULATIONS

Project Name	Proposed Industrial Building and Trailer Storage
Project Location	Perris, California
Project Number	22G250-2
Engineer	OS

Infiltration Test No I-1

Constants			
	Diameter (ft)	Area (ft ²)	Area (cm ²)
Inner	1	0.79	730
Anlr. Spac	2	2.36	2189

*Note: The infiltration rate was calculated based on current time interval

Test Interval		Time (hr)	Interval Elapsed (min)	Flow Readings				Infiltration Rates			
				Inner Ring (ml)	Ring Flow (cm ³)	Annular Ring (ml)	Space Flow (cm ³)	Inner Ring* (cm/hr)	Annular Space* (cm/hr)	Inner Ring* (in/hr)	Annular Space* (in/hr)
1	Initial	11:15 AM	30	0		0		3.84	4.02	1.51	1.58
	Final	11:45 AM	30	1400	1400	4400	4400				
2	Initial	11:45 AM	30	0		0		2.47	1.64	0.97	0.65
	Final	12:15 PM	60	900	900	1800	1800				
3	Initial	12:15 PM	30	0		0		2.19	1.83	0.86	0.72
	Final	12:45 PM	90	800	800	2000	2000				
4	Initial	12:45 PM	30	0		0		1.92	2.01	0.76	0.79
	Final	1:15 PM	120	700	700	2200	2200				
5	Initial	1:15 PM	30	0		0		1.64	1.83	0.65	0.72
	Final	1:45 PM	150	600	600	2000	2000				
6	Initial	1:45 PM	30	0		0		1.64	2.01	0.65	0.79
	Final	2:15 PM	180	600	600	2200	2200				

INFILTRATION CALCULATIONS

Project Name	Proposed Industrial Building and Trailer Storage
Project Location	Perris, California
Project Number	22G250-2
Engineer	OS

Infiltration Test No I-2

Constants			
	Diameter (ft)	Area (ft ²)	Area (cm ²)
Inner	1	0.79	730
Anlr. Spac	2	2.36	2189

*Note: The infiltration rate was calculated based on current time interval

Test Interval		Time (hr)	Interval Elapsed (min)	Flow Readings				Infiltration Rates				
				Inner Ring (ml)	Ring Flow (cm ³)	Annular Ring (ml)	Space Flow (cm ³)	Inner Ring* (cm/hr)	Annular Space* (cm/hr)	Inner Ring* (in/hr)	Annular Space* (in/hr)	
1	Initial	9:35 AM	30	0		0						
	Final	10:05 AM	30	200	200	1800	1800	0.55	1.64	0.22	0.65	
2	Initial	10:05 AM	30	0		0						
	Final	10:35 AM	60	200	200	800	800	0.55	0.73	0.22	0.29	
3	Initial	10:35 AM	30	0		0						
	Final	11:05 AM	90	100	100	600	600	0.27	0.55	0.11	0.22	
4	Initial	11:05 AM	30	0		0						
	Final	11:35 AM	120	100	100	600	600	0.27	0.55	0.11	0.22	
5	Initial	11:35 AM	30	0		0						
	Final	12:05 PM	150	100	100	600	600	0.27	0.55	0.11	0.22	
6	Initial	12:05 PM	30	0		0						
	Final	12:35 PM	180	100	100	600	600	0.27	0.55	0.11	0.22	

INFILTRATION CALCULATIONS

Project Name	Proposed Industrial Building and Trailer Storage
Project Location	Perris, California
Project Number	22G250-2
Engineer	OS

Infiltration Test No I-3

Constants			
	Diameter (ft)	Area (ft ²)	Area (cm ²)
Inner	1	0.79	730
Anlr. Spac	2	2.36	2189

*Note: The infiltration rate was calculated based on current time interval

Test Interval		Time (hr)	Interval Elapsed (min)	Flow Readings				Infiltration Rates			
				Inner Ring (ml)	Ring Flow (cm ³)	Annular Ring (ml)	Space Flow (cm ³)	Inner Ring* (cm/hr)	Annular Space* (cm/hr)	Inner Ring* (in/hr)	Annular Space* (in/hr)
1	Initial	7:00 AM	30	0		0		0.27	4.57	0.11	1.80
	Final	7:30 AM	30	100	100	5000	5000				
2	Initial	7:30 AM	30	0		0		0.11	0.73	0.04	0.29
	Final	8:00 AM	60	40	40	800	800				
3	Initial	8:00 AM	30	0		0		0.05	0.55	0.02	0.22
	Final	8:30 AM	90	20	20	600	600				
4	Initial	8:30 AM	30	0		0		0.00	0.00	0.00	0.00
	Final	9:00 AM	120	0	0	0	0				
5	Initial	9:00 AM	30	0		0		0.00	0.00	0.00	0.00
	Final	9:30 AM	150	0	0	0	0				
6	Initial	9:30 AM	30	0		0		0.00	0.00	0.00	0.00
	Final	10:00 AM	180	0	0	0	0				

INFILTRATION CALCULATIONS

Project Name	Proposed Industrial Building and Trailer Storage
Project Location	Perris, California
Project Number	22G250-2
Engineer	OS

Infiltration Test No I-4

Constants			
	Diameter (ft)	Area (ft ²)	Area (cm ²)
Inner	1	0.79	730
Anlr. Spac	2	2.36	2189

*Note: The infiltration rate was calculated based on current time interval

Test Interval		Time (hr)	Interval Elapsed (min)	Flow Readings				Infiltration Rates				
				Inner Ring (ml)	Ring Flow (cm ³)	Annular Ring (ml)	Space Flow (cm ³)	Inner Ring* (cm/hr)	Annular Space* (cm/hr)	Inner Ring* (in/hr)	Annular Space* (in/hr)	
1	Initial	10:00 AM	30	0		0						
	Final	10:30 AM	30	100	100	2800	2800	0.27	2.56	0.11	1.01	
2	Initial	10:30 AM	30	0		0						
	Final	11:00 AM	60	20	20	600	600	0.05	0.55	0.02	0.22	
3	Initial	11:00 AM	30	0		0						
	Final	11:30 AM	90	0	0	200	200	0.00	0.18	0.00	0.07	
4	Initial	11:30 AM	30	0		0						
	Final	12:00 PM	120	0	0	0	0	0.00	0.00	0.00	0.00	
5	Initial	12:00 PM	30	0		0						
	Final	12:30 PM	150	0	0	0	0	0.00	0.00	0.00	0.00	
6	Initial	12:30 PM	30	0		0						
	Final	1:00 PM	180	0	0	0	0	0.00	0.00	0.00	0.00	

Grain Size Distribution

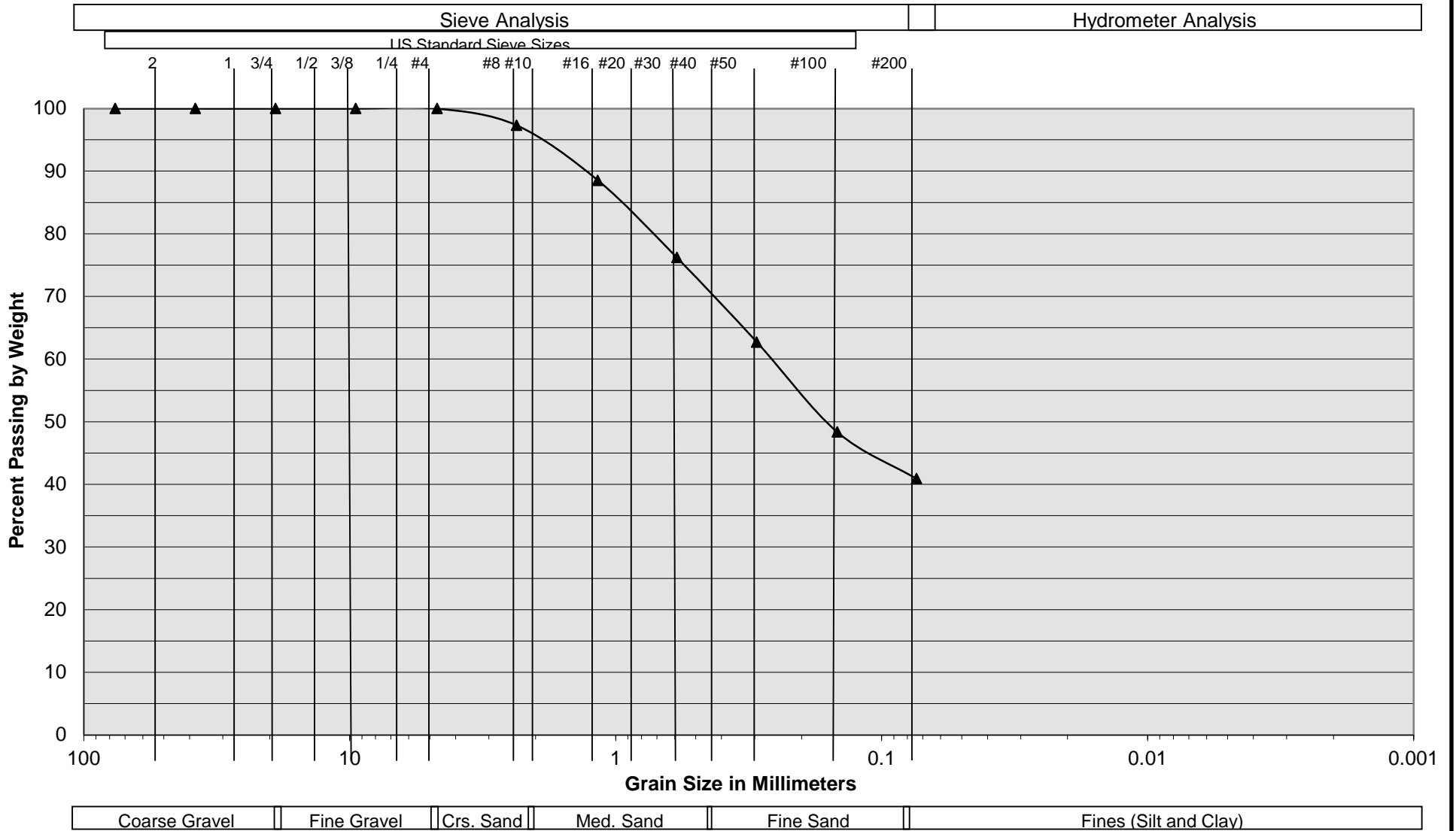

Sample Description	I-1 @ 7'
Soil Classification	Brown Silty fine to medium Sand, trace coarse Sand, trace to little Clay

Proposed Industrial Building and Trailer Storage
 Perris, California
 Project No. 22G250-2
PLATE C- 1





SOUTHERN CALIFORNIA GEOTECHNICAL
A California Corporation

Grain Size Distribution

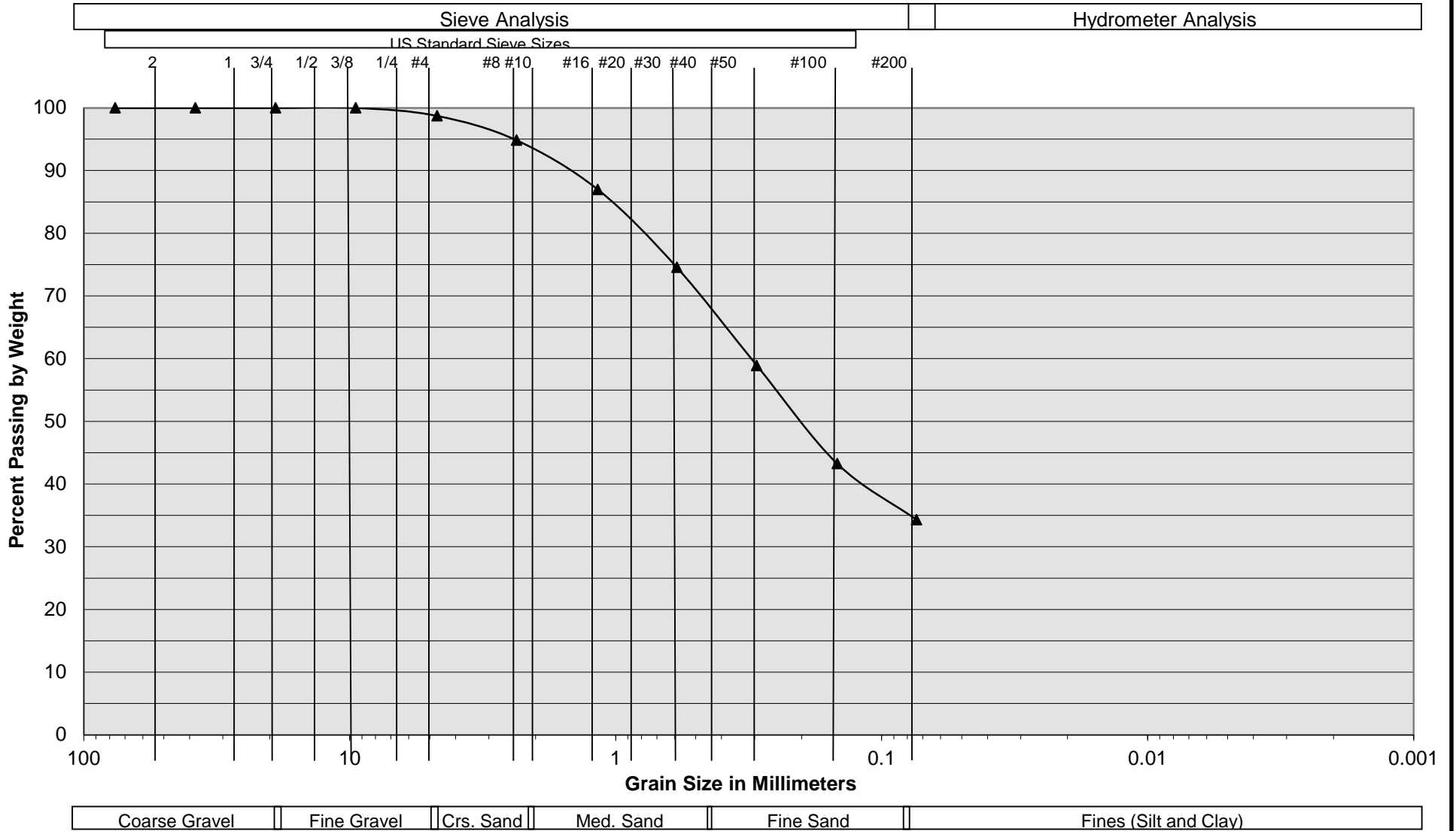

Sample Description	I-2 @ 11'
Soil Classification	Brown Silty fine to medium Sand, little coarse Sand, trace Clay

Proposed Industrial Building and Trailer Storage
 Perris, California
 Project No. 22G250-2
PLATE C- 2



SOUTHERN CALIFORNIA GEOTECHNICAL
A California Corporation

Grain Size Distribution

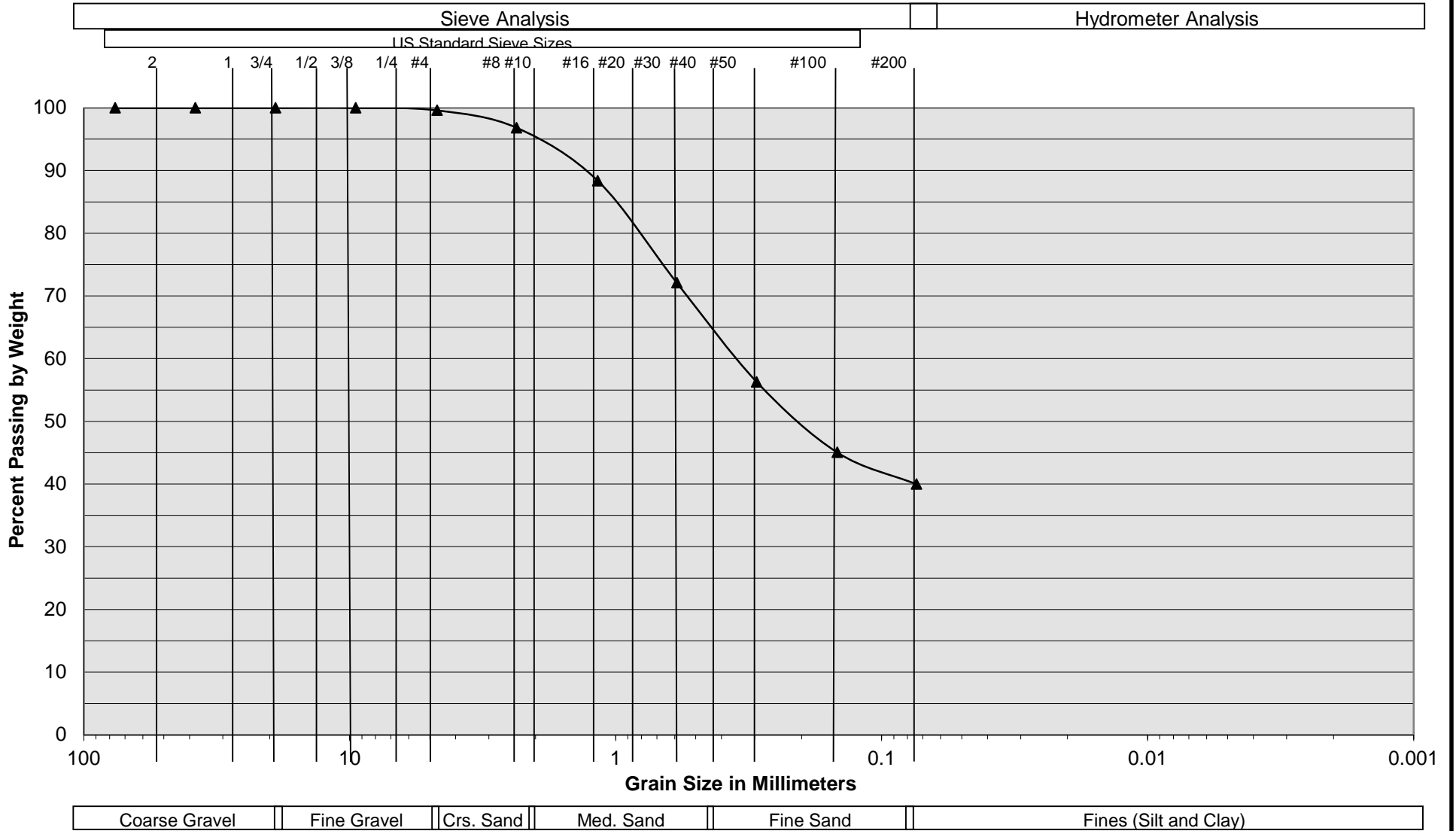

Sample Description	I-3 @ 7'
Soil Classification	Brown Silty fine to medium Sand, trace coarse Sand, trace Clay

Proposed Industrial Building and Trailer Storage
 Perris, California
 Project No. 22G250-2
PLATE C- 3



SOUTHERN CALIFORNIA GEOTECHNICAL
A California Corporation

Grain Size Distribution

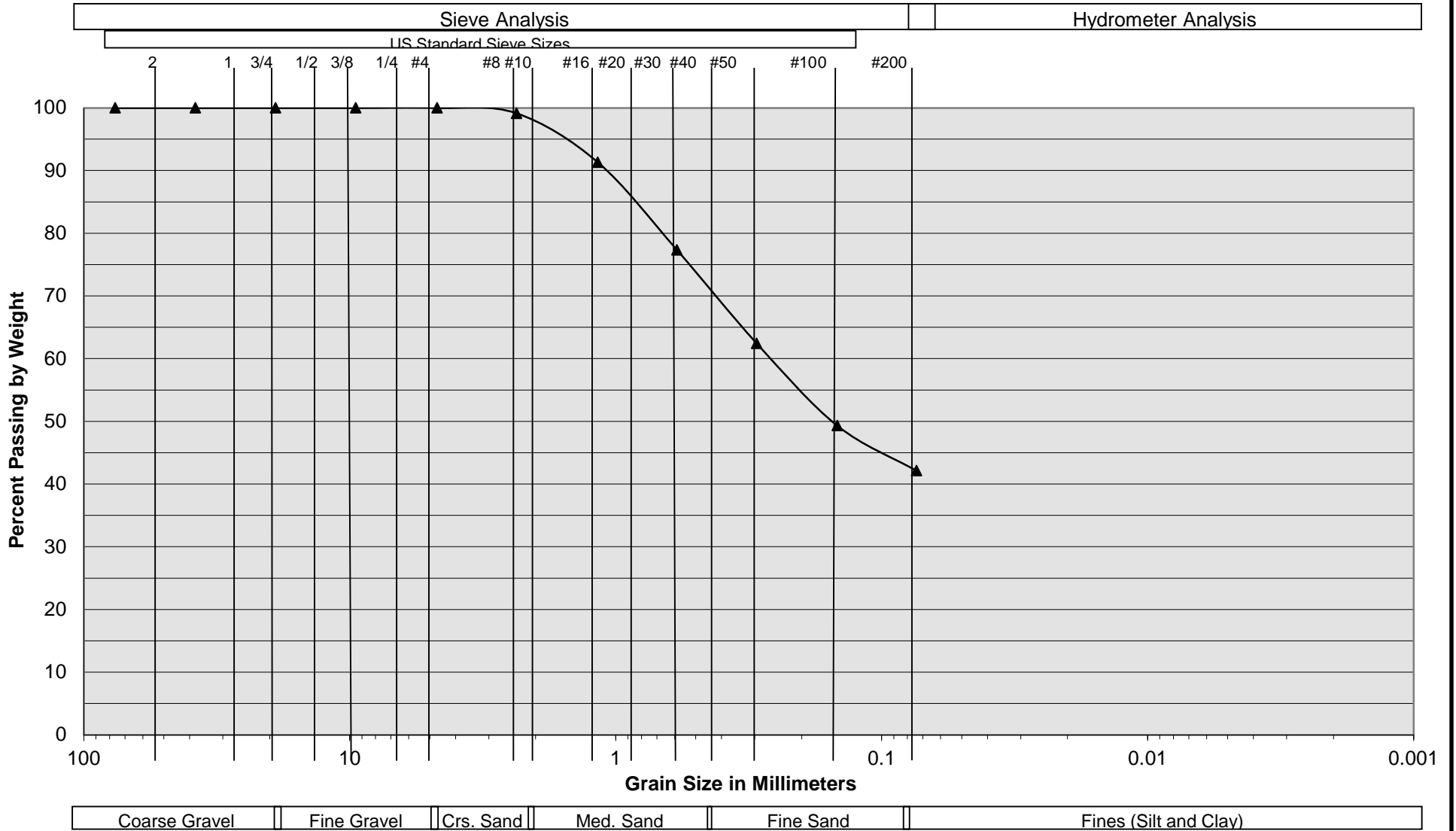

Sample Description	I-4 @ 10'
Soil Classification	Brown Silty fine to medium Sand, little Clay

Proposed Industrial Building and Trailer Storage
 Perris, California
 Project No. 22G250-2
PLATE C- 4





SOUTHERN CALIFORNIA GEOTECHNICAL
A California Corporation

Appendix 4: Historical Site Conditions

Phase I Environmental Site Assessment or Other Information on Past Site Use

PARTNER

Engineering and Science, Inc.



PHASE I ENVIRONMENTAL SITE ASSESSMENT REPORT

South Nance Street

Southeast Corner of Nance Street and
Nevada Avenue
Perris, California 92571

Report Date: July 26, 2022
Partner Project No. 22-378707.1



Prepared for:

Lake Creek Industrial LLC

1302 Brittany Cross Road
Santa Ana, California 92705

July 26, 2022

Mr. Michael Johnson
Lake Creek Industrial LLC
1302 Brittany Cross Road
Santa Ana, California 92705

Subject: Phase I Environmental Site Assessment
South Nance Street
Southeast Corner of Nance Street and Nevada Avenue
Perris, California 92571
Partner Project No. 22-378707.1

Dear Mr. Johnson:

Partner Engineering and Science, Inc. (Partner) is pleased to provide this *Phase I Environmental Site Assessment* (Phase I ESA) report of the abovementioned address (the "subject property"). This assessment was performed in conformance with the scope and limitations as detailed in the ASTM Practice E1527-13 and E1527-21 Standard Practice for Environmental Site Assessments: Phase I Environmental Site Assessment Process and Client Agreement.

This assessment included a site reconnaissance as well as research and interviews with representatives of the public, property ownership, site manager, and regulatory agencies. An assessment was made, conclusions stated, and recommendations outlined.

We appreciate your trust in Partner and the opportunity to provide environmental services to you. If you have any questions concerning this report, or if we can assist you in any other matter, please contact me at (310) 622-8855.

Sincerely,

DRAFT

Debbie Stott, P.G.
Principal

EXECUTIVE SUMMARY

Partner Engineering and Science, Inc. (Partner) has performed a Phase I Environmental Site Assessment (ESA) in accordance with the scope of work and limitations of ASTM Standard Practice E1527-13 and E1527-21, the Environmental Protection Agency Standards and Practices for All Appropriate Inquiries (AAI) (40 CFR Part 312) and set forth by Lake Creek Industrial LLC for the property located at the southeast corner of Nance Street and Nevada Avenue in the City of Perris, Riverside County, California (the "subject property").

Property Description

The subject property is located on the southeast corner of Nance Street and Nevada Avenue, within a generally commercial, light industrial and rural residential area of Riverside County. Please refer to the table below for further description of the subject property:

Subject Property Data

Address:	953 West Nance Street
Historical Addresses:	No other assigned addresses identified
Property Use:	Vacant land and a Residence (APN 314-160-015)
Number of Buildings:	1
Number of Floors:	1
Date of Construction:	1981
Assessor's Parcel Number (APN):	314-160-013, -014, -015, -016, -017, and -018
Current Tenants:	Vacant and individual residence
Zoning:	Commercial (PVCC SP)
Site Assessment Performed By:	Heather Hodgetts of Partner
Site Assessment Conducted On:	July 13, 2022
Regulatory Radius Report Date:	July 11, 2022
Lien Search Date:	NA
Report Date:	July 26, 2022
FOIAs Date:	July 2022

The subject property consists of six parcels of vacant land totaling 5.58 acres. The parcels are contiguous with a residence located in the center of the subject property separating the two vacant parcels on the west and the three vacant parcels to the east of the site. The vacant parcels at subject property are covered with low lying vegetation. At the time of the site visit, furniture and debris were observed on the northeast and southwest corners of the subject property. No other evidence of illegal dumping of solid waste was observed on the subject property during the Partner site reconnaissance.

No hazardous substances or petroleum products were observed on the subject property during the site reconnaissance. No evidence of aboveground storage tanks (ASTs) or underground storage tanks (USTs) such as fill ports, piping, or vent pipes was observed or reported onsite.

Based on the historical research and interviews, the subject property was agriculturally developed or vacant land from 1938 to present. By 1981, a small manufactured home was constructed on the north central boundary of the property. Tenants on the subject property include individual residential listings (953 West Nance Street) (1981-Present). No potential environmental concerns were identified in association with the current or former use of the subject property.

The agency database report obtained from May 10, 2022 did not identify the subject property.

During the vicinity reconnaissance, Partner observed the following land use on properties in the immediate vicinity of the subject property:

Immediately Surrounding Properties

- North:** West Nance Street, followed by residences/commercial properties at 4611 and 4697 Nevada Avenue, vacant land, Harley Knox Boulevard, and March Air Force Base.
- Northeast:** West Nance Street, followed by vacant land.
- East:** Auto Aide Towing (845 West Nance Street) and truck trailer lot (4990 North Webster Avenue).
- Southeast:** Residences/commercial properties at 912, 872, and 852 Washington Street.
- South:** Residences/commercial properties at 912, 872, and 852 Washington Street and XPO Logistics (4413 Patterson Avenue).
- Southwest:** A commercial property at XPO Logistics (4413 Patterson Avenue).
- West:** Vacant land
- Northwest:** Intersection of West Nance Street and Nevada Avenue, followed by vacant land.

No environmental concerns associated with adjacent properties were identified based on visual observation from publicly accessible rights-of-way.

No potential vapor intrusion concerns were identified onsite nor from offsite facilities.

According to information obtained from the California State Water Resource Control Board online database, GeoTracker, for a nearby property (Case Number T060652454 – Shell Perris #121222 at 4039 North Perris Boulevard) and topographic map interpretation, groundwater in the vicinity of the subject property is present at a depth of 80 feet below ground surface (bgs) and flows toward the west-southwest.

Findings and Opinions

Recognized Environmental Condition

A *recognized environmental condition (REC)* refers to the presence of hazardous substances or petroleum products in, on, or at the subject property due to a release to the environment; the likely presence of hazardous substances or petroleum products in, on, or at the subject property due to a release or likely release to the environment; or the presence of hazardous substances or petroleum products in, on, or at the subject property under conditions that pose a material threat of a future release to the environment. The following was identified during the course of this assessment:

- Partner did not identify any RECs during the course of this assessment.

Controlled Recognized Environmental Condition

A *controlled recognized environmental condition (CREC)* refers to a REC affecting the subject property that has been addressed to the satisfaction of the applicable regulatory authority or authorities with hazardous substances or petroleum products allowed to remain in place subject to implementation of required controls (for example, activity and use limitations or other property use limitations). The following was identified during the course of this assessment:

- Partner did not identify any CRECs during the course of this assessment.

Historical Recognized Environmental Condition

A *historical recognized environmental condition (HREC)* refers to a previous release of hazardous substances or petroleum products affecting the subject property that has been addressed to the satisfaction of the applicable regulatory authority or authorities and meeting unrestricted use criteria established by the applicable regulatory authority or authorities without subjecting the subject property to any controls (for example, activity and use limitations or other property use limitations). The following was identified during the course of this assessment:

- Partner did not identify any HRECs during the course of this assessment.

Business Environmental Risk

A *Business Environmental Risks (BER)* is a risk which can have a material environmental or environmentally driven impact on the business associated with the current or planned use of commercial real estate, not necessarily related to those environmental issues required to be investigated in this practice. The following was identified during the course of this assessment:

- Domestic wastewater generated at the subject property is likely disposed by means of the septic system. The septic system should be abandoned and removed under local requirements when no longer in use.
- Former water wells may be located at the subject property. If encountered in the future, the water wells should be abandoned and removed under local requirements if no longer in use.
- Due to the age of the subject property building, there is a potential that asbestos-containing material (ACM) is present. Suspect ACMs would need to be sampled to confirm the presence or absence of asbestos prior to any demolition activities.

Significant Data Gaps

No significant data gaps affecting the ability of the Environmental Professional to identify a REC were encountered during this assessment.

Conclusions and Recommendations

Partner has performed a Phase I Environmental Site Assessment in conformance with the scope and limitations of ASTM Practice E1527-13 and E1527-21 of the property at the southeast corner of Nance Street and Nevada Avenue in the City of Perris, Riverside County, California (the "subject property"). Any exceptions to, or deletions from, this practice are described in Section 1.5 of this report.

This assessment has revealed no evidence of RECs, CRECs, or HRECs in connection with the subject property; however, BERs were identified. Based on the conclusions of this assessment, Partner recommends no further investigation of the subject property at this time.

TABLE OF CONTENTS

1.0	INTRODUCTION.....	1
1.1	Purpose.....	1
1.2	Scope of Work.....	1
1.3	Limitations.....	2
1.4	User Reliance	3
1.5	Limiting Conditions	3
2.0	SITE DESCRIPTION	4
2.1	Site Location and Legal Description	4
2.2	Current Property Use.....	4
2.3	Current Use of Adjacent Properties	4
2.4	Physical Setting Sources.....	4
2.4.1	Topography.....	4
2.4.2	Hydrology.....	5
2.4.3	Geology/Soils	5
2.4.4	Flood Zone Information.....	5
3.0	HISTORICAL INFORMATION.....	6
3.1	Aerial Photograph Review	6
3.2	Fire Insurance Maps	7
3.3	City Directories.....	7
3.4	Historical Topographic Maps	8
4.0	REGULATORY RECORDS REVIEW	9
4.1	Regulatory Agencies.....	9
4.1.1	Health Department.....	9
4.1.2	Air Pollution Control Agency.....	9
4.1.3	Regional Water Quality Agency.....	9
4.1.4	Department of Toxic Substances Control	10
4.1.5	Building Department.....	10
4.1.6	Planning Department.....	10
4.1.5	Oil & Gas Exploration.....	10
4.1.6	Assessor's Office.....	11
4.2	Mapped Database Records Search.....	11
4.2.1	Regulatory Database Summary.....	11
4.2.2	Subject Property Listings	12
4.2.3	Adjoining Property Listings.....	12
4.2.4	Surrounding Area Listings of Concern to Subject Property.....	13
4.2.5	Unplottable Listings.....	14
5.0	USER PROVIDED INFORMATION AND INTERVIEWS.....	15
5.1	Interviews	15
5.1.1	Interview with Owner	15
5.1.2	Interview with Report User.....	16
5.1.3	Interview with Key Site Manager	16
5.1.4	Interviews with Past Owners, Operators and Occupants	16
5.1.5	Interview with Others	16
5.2	User Provided Information.....	16

5.2.1	Title Records, Environmental Liens, and AULs.....	16
5.2.2	Specialized Knowledge.....	16
5.2.3	Actual Knowledge of the User.....	16
5.2.4	Valuation Reduction for Environmental Issues.....	16
5.2.5	Commonly Known or Reasonably Ascertainable Information.....	17
5.2.6	Previous Reports and Other Provided Documentation.....	17
6.0	SITE RECONNAISSANCE.....	18
6.1	General Site Characteristics.....	18
6.2	Potential Environmental Hazards.....	19
6.3	Non-ASTM Services.....	20
6.3.1	Asbestos-Containing Materials (ACMs).....	20
6.3.2	Lead-Based Paint (LBP).....	20
6.3.3	Radon.....	20
6.3.4	Lead in Drinking Water.....	21
6.3.5	Mold.....	21
6.3.6	Wetlands.....	21
6.4	Adjoining Property Reconnaissance.....	21
7.0	VAPOR ENCROACHMENT CONDITIONS.....	22
8.0	FINDINGS AND CONCLUSIONS.....	23
9.0	SIGNATURES OF ENVIRONMENTAL PROFESSIONALS.....	25
10.0	REFERENCES.....	26

Figures

- Figure 1** Site Location Map
- Figure 2** Site Plan
- Figure 3** Topographic Map

Appendices

- Appendix A** Site Photographs
- Appendix B** Historical/Regulatory Documentation
- Appendix C** Regulatory Database Report
- Appendix D** Qualifications

1.0 INTRODUCTION

Partner Engineering and Science, Inc. (Partner) has performed a Phase I Environmental Site Assessment (ESA) in conformance with the scope and limitations of ASTM Standard Practice E1527-13 and the Environmental Protection Agency Standards and Practices for All Appropriate Inquiries (AAI) (40 CFR Part 312) for the property at southeast corner of Nance Street and Nevada Avenue in the City of Perris, Riverside County, California (the "subject property"). Any exceptions to, or deletions from, this scope of work are described in the report.

1.1 Purpose

The purpose of this ESA is to identify existing or potential Recognized Environmental Conditions (as defined by ASTM Standard E1527-13) affecting the subject property that: 1) constitute or result in a material violation or a potential material violation of any applicable environmental law; 2) impose any material constraints on the operation of the subject property or require a material change in the use thereof; 3) require clean-up, remedial action or other response with respect to Hazardous Substances or Petroleum Products on or affecting the subject property under any applicable environmental law; 4) may affect the value of the subject property; and 5) may require specific actions to be performed with regard to such conditions and circumstances. The information contained in the ESA Report will be used by Client to: 1) evaluate its legal and financial liabilities for transactions related to foreclosure, purchase, sale, loan origination, loan workout or seller financing; 2) evaluate the subject property's overall development potential, the associated market value and the impact of applicable laws that restrict financial and other types of assistance for the future development of the subject property; and/or 3) determine whether specific actions are required to be performed prior to the foreclosure, purchase, sale, loan origination, loan workout or seller financing of the subject property.

This ESA was performed to permit the *User* to satisfy one of the requirements to qualify for the innocent landowner, contiguous property owner, or bona fide prospective purchaser limitations on scope of Comprehensive Environmental Response, Compensation and Liability Act (CERCLA) (42 U.S.C. §9601) liability (hereinafter, the "*landowner liability protections*," or "*LLPs*"). ASTM Standard E1527-13 constitutes "*all appropriate inquiry* into the previous ownership and uses of the *property* consistent with good commercial or customary practice" as defined at 42 U.S.C. §9601(35)(B).

1.2 Scope of Work

The scope of work for this ESA is in accordance with the requirements of ASTM Standard E1527-13. This assessment included: 1) a property and adjacent site reconnaissance; 2) interviews with key personnel; 3) a review of historical sources; 4) a review of regulatory agency records; and 5) a review of a regulatory database report provided by a third-party vendor. Partner contacted local agencies, such as environmental health departments, fire departments and building departments in order to determine any current and/or former hazardous substances usage, storage and/or releases of hazardous substances on the subject property. Additionally, Partner researched information on the presence of activity and use limitations (AULs) at these agencies. As defined by ASTM E1527-13, AULs are the legal or physical restrictions or limitations on the use of, or access to, a site or facility: 1) to reduce or eliminate potential exposure to hazardous substances or petroleum products in the soil or groundwater on the subject

property; or 2) to prevent activities that could interfere with the effectiveness of a response action, in order to ensure maintenance of a condition of no significant risk to public health or the environment. These legal or physical restrictions, which may include institutional and/or engineering controls (IC/ECs), are intended to prevent adverse impacts to individuals or populations that may be exposed to hazardous substances and petroleum products in the soil or groundwater on the property.

If requested by Client, this report may also include the identification, discussion of, and/or limited sampling of asbestos-containing materials (ACMs), lead-based paint (LBP), mold, and/or radon.

1.3 Limitations

Partner warrants that the findings and conclusions contained herein were accomplished in accordance with the methodologies set forth in the Scope of Work. These methodologies are described as representing good commercial and customary practice for conducting an ESA of a property for the purpose of identifying recognized environmental conditions. There is a possibility that even with the proper application of these methodologies there may exist on the subject property conditions that could not be identified within the scope of the assessment or which were not reasonably identifiable from the available information. Partner believes that the information obtained from the record review and the interviews concerning the subject property is reliable. However, Partner cannot and does not warrant or guarantee that the information provided by these other sources is accurate or complete. The conclusions and findings set forth in this report are strictly limited in time and scope to the date of the evaluations. The conclusions presented in the report are based solely on the services described therein, and not on scientific tasks or procedures beyond the scope of agreed-upon services or the time and budgeting restraints imposed by the Client. No other warranties are implied or expressed.

Some of the information provided in this report is based upon personal interviews, and research of available documents, records, and maps held by the appropriate government and private agencies. This report is subject to the limitations of historical documentation, availability, and accuracy of pertinent records, and the personal recollections of those persons contacted.

This practice does not address requirements of any state or local laws or of any federal laws other than the all appropriate inquiry provisions of the LLPs. Further, this report does not intend to address all of the safety concerns, if any, associated with the subject property.

Environmental concerns, which are beyond the scope of a Phase I ESA as defined by ASTM include the following: ACMs, LBP, radon, and lead in drinking water. These issues may affect environmental risk at the subject property and may warrant discussion and/or assessment; however, are considered non-scope issues. If specifically requested by the Client, these non-scope issues are discussed in Section 6.3.

1.4 User Reliance

Lake Creek Industrial engaged Partner to perform this assessment in accordance with an agreement governing the nature, scope and purpose of the work as well as other matters critical to the engagement. All reports, both verbal and written, are for the sole use and benefit of Lake Creek Industrial and its entities. Either verbally or in writing, third parties may come into possession of this report or all or part of the information generated as a result of this work. In the absence of a written agreement with Partner granting such rights, no third parties shall have rights of recourse or recovery whatsoever under any course of action against Partner, its officers, employees, vendors, successors or assigns. Any such unauthorized user shall be responsible to protect, indemnify and hold Partner, Client and their respective officers, employees, vendors, successors and assigns harmless from any and all claims, damages, losses, liabilities, expenses (including reasonable attorneys' fees) and costs attributable to such Use. Unauthorized use of this report shall constitute acceptance of and commitment to these responsibilities, which shall be irrevocable and shall apply regardless of the cause of action or legal theory pled or asserted. Additional legal penalties may apply.

This report has been completed under specific Terms and Conditions relating to scope, relying parties, limitations of liability, indemnification, dispute resolution, and other factors relevant to any reliance on this report. Any parties relying on this report do so having accepted Partner's standard Terms and Conditions, a copy of which can be found at <http://www.partneresi.com/terms-and-conditions.php>.

1.5 Limiting Conditions

The findings and conclusions contain all of the limitations inherent in these methodologies that are referred to in ASTM E1527-13.

Specific limitations and exceptions to this ESA are more specifically set forth below:

- Interviews with past or current owners, operators and occupants were not reasonably ascertainable and thus constitute a data gap.
- An environmental cleanup lien search was not performed. However, it is Partner's opinion that the lack of the lien search does not represent a significant data gap, in that it does not impact Partner's ability to identify recognized environmental conditions at the subject property and therefore it does not alter the conclusions of this report. Preliminary title reports provided by Lake Creek Industrial did not indicate environmental liens filed against the property. According to the EDR Report, NPL (Superfund) and other environmental liens are not associated with the subject property. Based on available information, no environmental liens appear to be associated with the subject property.
- Partner observed 953 West Nance Street (APN 314-160-015) from West Nance Street and adjoining properties.

2.0 SITE DESCRIPTION

2.1 Site Location and Legal Description

The subject property is located at the southeast corner of Nance Street and Nevada Avenue in the City of Perris, Riverside County, California. The subject property was inspected by Heather Hodgetts of Partner on July 13, 2022. The weather at the time of the site visit was cloudy and in the mid-60s (degrees Fahrenheit). According to the Riverside County Assessor, is identified by Assessor's Parcel Numbers 302-314-160-013, -014, -015, -016, -017, and -018.

Please refer to Figure 1: Site Location Map, Figure 2: Site Plan, Figure 3: Topographic Map, and Appendix A: Site Photographs for the location and site characteristics of the subject property.

2.2 Current Property Use

The subject property consists of six parcels of vacant land totaling 5.58 acres. The parcels are contiguous with a residence located in the center of the subject property separating two vacant parcels on the west and three vacant parcels to the east of the site. The vacant parcels at subject property are covered with low lying vegetation. At the time of the site visit, furniture and debris were observed on the northeast and southwest corners of the subject property. No other evidence of illegal dumping of solid waste was observed on the subject property during the Partner site reconnaissance.

2.3 Current Use of Adjacent Properties

During the vicinity reconnaissance, Partner observed the following land use on properties in the immediate vicinity of the subject property:

Immediately Surrounding Properties

- North:** West Nance Street, followed by residences/commercial properties at 4611 and 4697 Nevada Avenue, vacant land, Harley Knox Boulevard, and March Air Force Base.
- Northeast:** West Nance Street, followed by vacant land.
- East:** Auto Aide Towing (845 West Nance Street) and truck trailer lot (4990 North Webster Avenue).
- Southeast:** Residences/commercial properties at 912, 872, and 852 Washington Street.
- South:** Residences/commercial properties at 912, 872, and 852 Washington Street and XPO Logistics (4413 Patterson Avenue).
- Southwest:** A commercial property at XPO Logistics (4413 Patterson Avenue).
- West:** Vacant land
- Northwest:** Intersection of West Nance Street and Nevada Avenue, followed by vacant land.

No environmental concerns associated with adjacent properties were identified based on visual observation from publicly accessible rights-of-way.

2.4 Physical Setting Sources

2.4.1 Topography

The United States Geological Survey (USGS) *Perris, California* Quadrangle 7.5-minute series topographic map was reviewed for this ESA. According to the contour lines on the topographic map, the subject property is located at approximately 1,484 feet above mean sea level (MSL). The contour lines in the area of the subject property indicate the area is sloping toward the west-southwest.

A copy of the most recent topographic map is included as Figure 3 of this report.

2.4.2 Hydrology

According to information obtained from the California State Water Resource Control Board online database, GeoTracker, for a nearby property (Case Number T060652454 – Shell Perris #121222 at 4039 North Perris Boulevard) and topographic map interpretation, groundwater in the vicinity of the subject property is present at a depth of 80 feet below ground surface (bgs) and flows toward the west-southwest.

No settling ponds, lagoons, surface impoundments, wetlands or natural catch basins were observed on the subject property during this assessment. The nearest surface water is the Perris Valley Storm Drain (Southern Storm Drain) located 0.25-miles to the north of the subject property.

2.4.3 Geology/Soils

The site is located in the Peninsular Ranges geomorphic province. The Peninsular Ranges are a northwest-southwest oriented complex of blocks separated by similarly trending faults. They extend from the Transverse Ranges and the Los Angeles Basin south to the Mexican border and beyond to the tip of Baja California and are bounded on the east by the Colorado Desert and the Gulf of California. The Peninsular Ranges contain minor Jurassic and extensive Cretaceous igneous rocks associated with the Nevadan plutonism. Marine Cretaceous sedimentary rocks are well represented and post-Cretaceous rocks form a restricted veneer of volcanic, marine, and nonmarine sediments.

Based on information obtained from the USDA Natural Resources Conservation Service Web Soil Survey online database, the subject property is mapped as Pachappa fine sandy and Ramona sandy loam. These series consists of well drained alluvium derived from granite. Slopes range from 0 to 2 percent.

2.4.4 Flood Zone Information

Partner performed a review of the Flood Insurance Rate Map, published by the Federal Emergency Management Agency. According to Community Panel Number 06065C1430H, dated August 18, 2014, the northeast corner of the subject property appears to be located in Zone D, an area of undetermined flood risk. The remainder of the subject property is mapped in Zone X, an area of minimal flood risk.

3.0 HISTORICAL INFORMATION

Partner obtained historical use information about the subject property from a variety of sources. A chronological listing of the historical data found is summarized in the table below:

Historical Use Information		
Years	Resource	Description/Use
1938-1976	Aerial Photographs, Topographic Map	Agricultural or Vacant Land
1981-Present	Aerial Photographs, Topographic Map, City Directories, Onsite Observations	Agricultural or Vacant Land, with a Residence

Based on the historical research and interviews, the subject property was agriculturally developed or vacant land from 1938 to present. By 1981, a small manufactured home was constructed on the north central boundary of the property. Tenants on the subject property include individual residential listings (953 West Nance Street) (1981-Present). No potential environmental concerns were identified in association with the current or former use of the subject property.

Common agricultural practices can result in residual concentrations of fertilizers, pesticides or herbicides in near-surface soil, though not generally at concentrations that pose a significant health risk. It is Partner’s opinion that, the property has been tilled, and remaining pesticide or herbicide residues, if any, are likely to have been dispersed and therefore are unlikely to impact human health or the environment. Accordingly, no further investigation is recommended regarding potential residual pesticides.

3.1 Aerial Photograph Review

Partner obtained available aerial photographs of the subject property and surrounding area from Environmental Risk Information Services (ERIS) on July 12, 2022. The inferred uses of the subject property and adjoining properties as interpreted from the aerial photographs in Appendix B are tabulated below:

Date:	1938-1976	Scale:	1"=500'
Subject Property:	Agricultural land.		
North:	West Nance Street, followed by agricultural land. By 1953, residential properties are located to the north along Nevada Avenue.		
Northeast:	West Nance Street, followed by agricultural land.		
East:	Agricultural land. By 1970, a commercial property is located further to the east.		
Southeast:	Agricultural land.		
South:	Agricultural land.		
Southwest:	Agricultural land.		
West:	Agricultural land. By 1953, Nevada Avenue is located to the west.		
Northwest:	West Nance Street, followed by agricultural land. By 1953, Nevada Avenue is located to the west. By 1970, a residential/commercial property is located to the northwest.		

Date:	1985-2020	Scale:	1"=500'
Subject Property:	Developed with a residence on the central north boundary of the site. The remainder of the site appears to be agricultural or vacant land		
North:	West Nance Street, followed by agricultural or vacant land and residential properties.		
Northeast	West Nance Street, followed by agricultural or vacant land.		
East:	Commercial properties, followed by North Webster Avenue.		
Southeast	Agricultural or vacant land and residential/commercial properties, followed by		

Date: 1985-2020

Scale: 1"=500'

South: Washington Street. Agricultural or vacant land and residential/commercial properties, followed by Washington Street. By 2018, a large commercial building is under construction.

Southwest: Nevada Avenue, followed by agricultural or vacant land. By 2018, a large commercial building is under construction.

West: Nevada Avenue, followed by agricultural or vacant land. By 2009, a commercial yard is located further west.

Northwest: West Nance Street and Nevada Avenue, followed by agricultural or vacant land and a residential/commercial property.

Copies of select aerial photographs are included in Appendix B of this report.

3.2 Fire Insurance Maps

Partner requested Fire insurance maps (FIMs) from ERIS on July 12, 2022. FIM coverage was not available for the subject property.

A copy of the "No Coverage" letter is included in Appendix B of this report.

3.3 City Directories

Partner reviewed historical city directories obtained from ERIS on May 16, 2022 and July 12, 2022 for past names and businesses that were listed for the subject property and adjoining properties. The findings are tabulated below:

City Directory Search for 953 West Nance Street

Year(s)	Occupant Listed
----------------	------------------------

1991-2012	Individual residential listings (953 West Nance Street)
-----------	---

According to the city directory review, the subject property has been occupied by residential properties. Based on the city directory review, no environmentally sensitive listings were identified for the subject property address.

City Directory Search for South Adjoining Properties

Year(s)	Occupant Listed
----------------	------------------------

1977-19	Individual residential listings (18194 Washington Street)
1984-1991	Individual residential listings (23940 and 23980 Washington Street)
1991	Individual residential listings (832-872 Washington Street)
2003	Orange Auto Classics (845 West Nance Street)
2008	OC Collision, Travis L Haugen (845 West Nance Street)
2008-2020	Dan Ruth (845 West Nance Street)
2016-2020	Virginni Schexnayde (845 West Nance Street)
2020	U-Haul Neighborhood Dealer (845 West Nance Street)
2020	Firehouse 64 (832 Washington Street)
2016-2020	Smedley's Towing (912 Washington Street)
2016	J&J's Towing (852 Washington Street)

According to the city directory review, the adjoining properties have been occupied by residential and commercial listings since the late 1970s. Based on the city directory review, no environmentally sensitive listings were identified for the adjoining property addresses.

Copies of reviewed city directories are included in Appendix B of this report.

3.4 Historical Topographic Maps

Partner reviewed historical topographic maps obtained from ERIS on July 12, 2022. The following inferred uses of the subject property and adjoining properties interpreted from topographic maps in Appendix B and are tabulated below:

Date:	1942, 1943, 1953
Subject Property:	Vacant land.
North:	West Nance Street, followed by vacant land. By 1953, three structures are located along Nevada Avenue. March Air Force Base is depicted further to the north.
Northeast:	West Nance Street, followed by vacant land.
East:	Vacant land.
Southeast:	Vacant land.
South:	Vacant land.
Southwest:	Vacant land. By 1953, Nevada Avenue is located adjoining to the west.
West:	Vacant land. By 1953, Nevada Avenue is located adjoining to the west.
Northwest:	West Nance Street, followed by vacant land. By 1953, Nevada Avenue is located adjoining to the west.

Date:	1967, 1973, 1979
Subject Property:	Vacant land. The subject property appears to be located adjoining to the west of a March Air Force Base boundary line.
North:	West Nance Street, followed by vacant land and three structures along Nevada Avenue.
Northeast:	West Nance Street, followed by vacant land.
East:	Vacant land, followed by one structure and North Webster Avenue.
Southeast:	Vacant land.
South:	Vacant land.
Southwest:	Nevada Avenue, followed by vacant land.
West:	Nevada Avenue, followed by vacant land. A water well is located further west.
Northwest:	Vacant land, followed by three structures along Nevada Avenue.

Date:	2015, 2018, 2021
Subject Property:	Vacant land. The subject property appears to be located adjoining to a March Air Force Base boundary line.
North:	Vacant land. March Air Force Base boundary line is located to the north. March Air Force Base is depicted further to the north.
Northeast:	West Nance Street, followed by vacant land.
East:	Vacant land, followed by one structure and North Webster Avenue.
Southeast:	Vacant land.
South:	Vacant land.
Southwest:	Nevada Avenue, followed by vacant land.
West:	Nevada Avenue, followed by vacant land. A water well is located further west.
Northwest:	Vacant land, followed by three structures along Nevada Avenue.

Copies of reviewed topographic maps are included in Appendix B of this report.

4.0 REGULATORY RECORDS REVIEW

4.1 Regulatory Agencies

4.1.1 Health Department

Regulatory Agency Data

Name of Agency:	Riverside County Health Department of Environmental Health (RCDEH)
Point of Contact:	Records Coordinator
Agency Address:	4065 County Circle Drive, Room 104
Agency Phone Number:	(951) 358-7018
Date of Contact:	July 20, 2022
Method of Communication:	Email
Summary of Communication:	As of the date of this report, Partner has not received a response from the RCDEH for inclusion in this report.

The RCDEH Hazardous Materials Management Division is unable to provide information about sites based on APN's or similar geographic site data. No addresses have been identified for the subject property.

4.1.2 Air Pollution Control Agency

Regulatory Agency Data

Name of Agency:	South Coast Air Quality Management District (SCAQMD)
Point of Contact:	http://www.aqmd.gov/nav/FIND/facility-information-detail
Agency Address:	21865 Copley Drive, Diamond Bar, California 91765
Agency Phone Number:	(909) 396-2000
Date of Contact:	July 20, 2022
Method of Communication:	Online
Summary of Communication:	No Permits to Operate (PTO), Notices of Violation (NOV), or Notices to Comply (NTC) or the presence of AULs, dry cleaning machines, or USTs were on file for the subject property with the SCAQMD.

4.1.3 Regional Water Quality Agency

Regulatory Agency Data

Name of Agency:	Regional Water Quality Control Board (RWQCB)
Point of Contact:	http://geotracker.waterboards.ca.gov/
Agency Address:	3737 Main St Ste 500, Riverside, CA 92501
Agency Phone Number:	(951) 782-4130
Date of Contact:	July 20, 2022
Method of Communication:	Online database
Summary of Communication:	The subject property was not identified on the GeoTracker database. Partner received a response on July 20, 2022 from the RWQCB indicating they had no records for the subject property.

4.1.4 Department of Toxic Substances Control

Regulatory Agency Data

Name of Agency:	California Department of Toxic Substances Control (DTSC)
Agency Address:	http://www.envirostor.dtsc.ca.gov/public/ http://www.hwts.dtsc.ca.gov/
Agency Phone Number:	(714) 484-5400
Date of Contact:	July 20, 2022
Method of Communication:	Online
Summary of Communication:	Partner received a response on July 25, 2022 from the DTSC indicating they had no records for the subject property. The subject property address was not identified in the online DTSC EnviroStor and Hazardous Waste Tracking System databases.

4.1.5 Building Department

Regulatory Agency Data

Name of Agency:	City of Perris Building & Safety (PBS)
Point of Contact:	https://www.cityofperris.org/departments/development-services/building-department
Agency Address:	101 North D Street, Perris, CA 92570
Agency Phone Number:	(951) 943-6100
Date of Contact:	July 20, 2022
Method of Communication:	Online
Summary of Communication:	Records were not identified in the PBS online database for subject property parcels (APNs 314-160-013, -014, -015, -016, -017, and -018).

4.1.6 Planning Department

Regulatory Agency Data

Name of Agency:	City of Perris Planning Department
Point of Contact:	https://www.cityofperris.org/departments/development-services/zoning
Agency Address:	101 North D Street, Perris, CA 92570
Agency Phone Number:	(951) 943-6100
Date of Contact:	July 20, 2022
Method of Communication:	Online
Summary of Communication:	According to records reviewed, the subject property is zoned for industrial development (Perris Valley Commerce Center Specific Plan - PVCC SP) by the City of Perris.

4.1.5 Oil & Gas Exploration

Regulatory Agency Data

Name of Agency:	California Division of Oil, Gas and Geothermal Resources (CalGem)
Point of Contact:	http://maps.conservation.ca.gov/doms/doms-app.html
Agency Address:	801 K Street, MS 24-01, Sacramento, California 95814
Agency Phone Number:	(916) 322-1080
Date of Contact:	July 20, 2022
Method of Communication:	Online
Summary of Communication:	According to CalGem, no oil or gas wells are located on or adjacent to the subject property.

4.1.6 Assessor's Office

Regulatory Agency Data

Name of Agency:	Riverside County Assessor (RCA)
Point of Contact:	https://ca-riverside-acr.publicaccessnow.com/
Agency Address:	4080 Lemon St, 1st Floor Riverside, CA 92501
Agency Phone Number:	(951) 955-9553
Date of Contact:	May 9, 2022
Method of Communication:	Online
Summary of Communication:	According to records reviewed, the subject property is identified by APNs 314-160-013, -014, -015, -016, -017, and -018. One address was identified 953 West Nance Street (314-160-015) and a manufactured home was constructed in 1981. No other addresses were identified for the subject property.

Copies of pertinent documents obtained by Partner from the above-referenced agencies are included in Appendix B.

4.2 Mapped Database Records Search

The regulatory database report provided by Environmental Risk Information Services (ERIS) documents the listing of sites identified on federal, state, county, city, and tribal (when applicable) standard source environmental databases within the approximate minimum search distance (AMSD) specified by ASTM E1527-13 and E1527-21. The data from these sources are updated as these data are released and integrated into one database. The information contained in this report was compiled from publicly available sources.

The environmental database information is used to identify environmental concerns in connection with the subject property. The listings also serve to identify the known indications of the storage, use, generation, disposal, or release of hazardous substance at the subject property and the potential for contaminants to migrate onto the subject property from off-site sources in groundwater or soil in the form of liquids or vapor.

Using the ASTM definition of migration, Partner considers the migration of hazardous substances or petroleum products in any form onto the subject property during the evaluation of each site listed on the radius report, which includes solid, liquid, and vapor.

4.2.1 Regulatory Database Summary

The following table lists the number of sites as categorized by the regulatory database within the prescribed AMSD. The locations of the sites are plotted utilizing a geographic information system, which geocodes the site addresses. The accuracy of the geocoded locations is approximately +/-300 feet.

Radius Report Data

Database	AMSD Radius (mile)	Listings Identified		Surrounding Area Sites of Concern
		Subject Property	Adjoining Properties	
Federal NPL	1.00	N	N	Y
Delisted NPL Site	0.50	N	N	N
Federal SEMS Site	0.50	N	N	N

Radius Report Data

Database	AMSD Radius (mile)	Listings Identified		Surrounding Area Sites of Concern
		Subject Property	Adjoining Properties	
Federal SEMS-ARCHIVE	0.50	N	N	N
Federal RCRA CORRACTS Facility	1.00	N	N	N
Federal RCRA TSDF Facility	0.50	N	N	N
Federal RCRA Generators Site (LQG, SQG, VSQG, CESQG, NonGen)	Subject and Adjoining	N	Y	N/A
Federal IC/EC Registries	Subject Property	N	N/A	N/A
Federal ERNS Site	Subject Property	N	N/A	N/A
State/Tribal Equivalent NPL	1.00	N	N	N
State/Tribal Equivalent CERCLIS	1.00	N	N	N
State/Tribal Landfill/Solid Waste Disposal Site	0.50	N	N	N
State/Tribal Leaking Storage Tank Site (LUST/LPST)	0.50	N	N	N
State/Tribal Registered Storage Tank Sites (UST/AST)	Subject and Adjoining	N	N	N/A
State/Tribal IC/EC Registries	Subject and Adjoining	N	N	N/A
State/Tribal Voluntary Cleanup Sites (VCP)	0.50	N	N	N
State/Tribal Spills	0.50	N	N	N
Federal Brownfield Sites	0.50	N	N	N
State Brownfield Sites	0.50	N	N	N
CHMIRS, CERS Haz	Subject and Adjoining	N	Y	

4.2.2 Subject Property Listings

The subject property is not identified in the regulatory database report.

4.2.3 Adjoining Property Listings

The following adjoining properties are identified in the regulatory database report, as discussed below:

- Riverside Co. Fire Dept. (ERIS Map ID: 1)**, listed at 912 Washington Street, located adjoining to the south, and hydrologically cross- to down-gradient of the subject property. This facility is identified on the CHMIRS database. According to the CHMIRS database, a release of motor oil was reported on November 19, 1998. According to notes, private contracting company that does fire prevention for City of Perris found waste oil abandoned at a residence during code enforcement inspection. Based on the regulatory status, it is Partner's opinion that this listing does not represent an environmental concern to the subject property.
- GXO Logistics, XPO Logistics Supply Chain, GAMA Bro's (ERIS Map ID: 2)**, listed at 4413 Patterson Avenue, located adjoining to the south-southwest and hydrologically cross-gradient of the subject property. This facility is identified on the CERS Haz, FINDS/FRS, HWG Riverside, HZH Riverside, RCRA SQG, and RCRA NonGen databases. No RCRA violations were listed. The facility was last inspected on June 17, 2021 by the Riverside County Department of Environmental Health.

Violations were issued for failure to obtain an Identification Number prior to treating, storing, disposing of, transporting or offering for transportation any hazardous waste, failure to complete and electronically submit hazardous material inventory information for all reportable hazardous materials on site at or above reportable quantities, and failure to provide initial and annual training to all employees in safety procedures. The facility returned to compliance on July 22, 2021. It was noted that This facility is a warehouse distribution center that handles lead acid batteries and diesel fuel. Based on the regulatory status, it is Partner's opinion that these listings do not represent an environmental concern to the subject property.

- **Auto Aid (ERIS Map ID: 3)**, listed at 845 West Nance Street, located adjoining to the east, beyond West Nance Street, and hydrologically down-gradient of the subject property. This facility is identified on the RCRA NonGen database. No RCRA violations were listed. Based on the regulatory status, it is Partner's opinion that this listing does not represent an environmental concern to the subject property.

Based on the findings, vapor migration is not expected to represent a significant environmental concern at this time.

4.2.4 Surrounding Area Listings of Concern to Subject Property

- The following site of concern was identified: The subject property is situated downgradient of known groundwater contamination, identified as the March Air Force Base/March Air Reserve Base (ARB) Superfund site, Former Fire Training Area (FT007). The facility is listed on the NPL. March ARB is located approximately 0.16-miles to the north-northwest. According to information obtained from the regulatory database report and the GeoTracker and the EnviroStor online databases, numerous releases have been discovered throughout the March ARB property since the late-1980s. Contaminated groundwater is known to have migrated off March ARB property to the southeast and is mapped beneath the subject property. Groundwater in the vicinity of the base has reportedly been impacted with by numerous hazardous substances, including volatile organic compounds (VOCs), specifically trichloroethylene (TCE), tetrachloroethylene (PCE), carbon tetrachloride (CTCL), as well as Perfluorooctane Sulfonic acid (PFOS), and Perfluorooctanoic acid (PFAS). VOC contamination in groundwater beneath and adjacent to Site FT007 was first investigated and remediated under Operable Unit 1 (OU1). A groundwater extraction and treatment system (GETS) was installed in 1991, to operate as an interim remedy to prevent further migration of TCE and PCE plumes at the base boundary.

According the Final (Revised) Expanded Inspection Report (ESI) for Perfluorooctane Sulfonic Acid and Perfluorooctanoic Acid for the former March Air Force Base dated December 2020, FT007 is a former fire-fighting training area for which previous investigations have confirmed the presence of PFOS and PFOA in groundwater at concentrations above the U.S. Environmental Protection Agency (USEPA) Lifetime Health Advisories (LHAs). The United States Air Force is currently focused on protecting human health primarily through the investigation of drinking water.

As a part of the field investigation, groundwater samples were collected from existing and newly installed groundwater monitoring wells. Twelve new groundwater monitoring wells were installed as nested wells within five separate boreholes strategically located to determine the horizontal and vertical extent of PFOS and PFOA in groundwater above the LHA. Currently, there are no legally enforceable federal or State of California criteria for PFAS. In October 2019, the DoD issued a memorandum identifying risk-based screening levels calculated using the USEPA Regional Screening Level (RSL) calculator for PFOA, PFOS, and PFBS in groundwater and soil.

In April 2021, the USEPA released an updated toxicity assessment for PFBS only, which resulted in revised screening levels for PFBS (USEPA, 2021). The most current USEPA RSLs for PFOS, PFOA, and PFBS, using the conservative residential scenario, will be used as screening levels. These screening values will be used to determine if further investigation is needed or if a site can proceed to closeout. The current residential screening levels for PFOS, PFOA, and PFBS, assuming a hazard quotient (HQ) of 0.1, are: for soil - 130 micrograms per kilogram (ug/kg); 130 ug/kg; and 1900 ug/kg; and for residential tap water – 40 nanograms per liter (ng/L); 40 ng/L; and 602 ng/L.

Attached figures indicated the subject property is depicted to the west of the FT007 Study Area Boundary. Attached figures indicated the PFOS+PFOA plume in the upper aquifer is mapped below the site vicinity in nearby wells to the east. PFOS and PFOA compounds are non-volatile, and therefore do not represent a vapor intrusion risk. Contaminated groundwater is actively being remediated at March AFB, and groundwater is not utilized at the subject property as source of drinking water. Based on regulatory oversight, the identification of a responsible party, and municipal water supply, the groundwater contamination associated with the nearby March ARB does not represent a significant environmental concern for the subject property.

Based on the findings, vapor migration is not expected to represent a significant environmental concern at this time.

4.2.5 Unplottable Listings

No unplottable listings are identified in the regulatory database report.

A copy of the regulatory database report is included in Appendix C of this report.

5.0 USER PROVIDED INFORMATION AND INTERVIEWS

In order to qualify for one of the *Landowner Liability Protections (LLPs)* offered by the Small Business Liability Relief and Brownfields Revitalization Act of 2001 (the *Brownfields Amendments*), the *User* must conduct the following inquiries required by 40 CFR 312.25, 312.28, 312.29, 312.30, and 312.31. The *User* should provide the following information to the *environmental professional*. Failure to provide this information could result in a determination that *all appropriate inquiries* is not complete. The *User* is asked to provide information or knowledge of the following:

- Review Title and Judicial Records for Environmental Liens and AULs
- Specialized Knowledge or Experience of the User
- Actual Knowledge of the User
- Reason for Significantly Lower Purchase Price
- Commonly Known or *Reasonably Ascertainable* information
- Degree of Obviousness
- Reason for Preparation of this Phase I ESA

Fulfillment of these user responsibilities is key to qualification for the identified defenses to CERCLA liability. Partner requested our Client to provide information to satisfy User Responsibilities as identified in Section 6 of the ASTM guidance.

Pursuant to ASTM E1527-13 and E1527-21, Partner requested the following site information from Lake Creek Industrial (User of this report).

User Responsibilities

Item	Provided By User	Not Provided By User
AAI User Questionnaire	X	
Title Records, Environmental Liens, and AULs	X	
Specialized Knowledge		X
Actual Knowledge		X
Valuation Reduction for Environmental Issues		X
Identification of Key Site Manager		X
Reason for Performing Phase I ESA	X	
Prior Environmental Reports		X
Other		X

5.1 Interviews

5.1.1 Interview with Owner

The owner of the subject property was not available to be interviewed at the time of the assessment.

5.1.2 Interview with Report User

Please refer to Section 5.2 below for information requested from the Report User. The information requested was not received prior to the issuance of this report. Because the Report User (Client) is a lender or potential purchaser, it is understood that the Report User would not have knowledge of the property that would significantly impact our ability to satisfy the objectives of this assessment. The lack of this information is not considered to represent a significant data gap.

5.1.3 Interview with Key Site Manager

A key site manager was not provided to be interviewed at the time of this assessment.

5.1.4 Interviews with Past Owners, Operators and Occupants

Interviews with past owners, operators and occupants were not conducted since information regarding the potential for contamination at the subject property was obtained from other sources.

5.1.5 Interview with Others

As the subject property is not an abandoned property as defined in ASTM 1527-13, interview with others were not performed.

5.2 User Provided Information

5.2.1 Title Records, Environmental Liens, and AULs

Partner was provided by Lake Creek Industrial with a Preliminary Title Report issued by Old Republic Title and dated June 6, 2022 for some of the subject property. According to the Commitment for Title Insurance, the title to the subject property is currently vested in:

- APNs 314-160-013; 314-160-014; 314-160-016; 314-160-017; and 314-160-018: Mader Incorporated, a California corporation.
- APN: 314-160-015: no Preliminary Title Report provided.

No apparent environmental liens or AULs were identified for the subject property based on the review of the Preliminary Title Report.

Copies are included in Appendix B.

5.2.2 Specialized Knowledge

No specialized knowledge of environmental conditions associated with the subject property was provided by the User at the time of the assessment.

5.2.3 Actual Knowledge of the User

No actual knowledge of any environmental lien or AULs encumbering the subject property or in connection with the subject property was provided by the User at the time of the assessment.

5.2.4 Valuation Reduction for Environmental Issues

No knowledge of valuation reductions associated with the subject property was provided by the User at the time of the assessment.

5.2.5 Commonly Known or Reasonably Ascertainable Information

The User did not provide information that is commonly known or *reasonably ascertainable* within the local community about the subject property at the time of the assessment.

5.2.6 Previous Reports and Other Provided Documentation

No previous reports or other pertinent documentation was provided to Partner for review during the course of this assessment.

6.0 SITE RECONNAISSANCE

The weather at the time of the site visit was cloudy. Refer to Section 1.5 for limitations encountered during the field reconnaissance and Sections 2.1 and 2.2 for subject property operations. The table below provides the site assessment details:

Site Assessment Data

Site Assessment Performed By:	Heather Hodgetts
Site Assessment Conducted On:	July 13, 2022

Partner was unaccompanied during the field reconnaissance activities.

No potential environmental concerns were identified during the onsite reconnaissance.

6.1 General Site Characteristics

6.1.1 Solid Waste Disposal

Solid waste generated at the subject property is disposed of in trash cans located at 953 West Nance Street (APN 314-160-015) at the subject property. An independent solid waste disposal contractor removes solid waste from the subject property. Solid waste generated at the subject property includes household trash.

Furniture and minor debris were observed on the northeast and southwest portion of the property. No other evidence of illegal dumping of solid waste was observed on the subject property during the Partner site reconnaissance.

6.1.2 Sewage Discharge and Disposal

The municipal sanitary sewer system operated by the City of Perris services the subject property vicinity.

A septic system is likely located in the 953 West Nance Street (APN 314-160-015). No wastewater treatment facilities are located on the subject property.

6.1.3 Surface Water Drainage

Storm water is removed from the subject property primarily by percolation to unpaved ground surfaces on the subject property.

6.1.4 Source of Heating and Cooling

Electricity and natural gas are provided to the vicinity by Southern California Edison (SCE) and the Southern California Gas Company.

6.1.5 Wells and Cisterns

No aboveground evidence of wells or cisterns was observed during the site reconnaissance.

Water wells may be located at the subject property due to the historical agricultural use. If encountered, the water wells should be abandoned under local requirements.

6.1.6 Wastewater

Domestic wastewater is not generated at the subject property.

6.1.7 Septic Systems

A septic system is likely located in the 953 West Nance Street (APN 314-160-015). The septic system was likely installed during constructed in 1981.

6.1.8 Additional Site Observations

No other additional general site characteristics were observed during the site reconnaissance.

6.2 Potential Environmental Hazards

6.2.1 Hazardous Substances and Petroleum Products Used or Stored at the Site

Small quantities of household cleaning products and general maintenance supplies are likely located in the 953 West Nance Street (APN 314-160-015). No signs of container leakage or significant corroding or staining of the concrete or asphalt surfaces in the vicinity of the materials, or drains nearby. The storage and use of maintenance supplies is not a significant environmental concern.

6.2.2 Aboveground & Underground Hazardous Substance or Petroleum Product Storage Tanks (ASTs/USTs)

No evidence of ASTs or USTs such as fill ports, piping, or vent pipes was observed or reported onsite.

6.2.3 Evidence of Releases

No spills, stains or other indications that a surficial release has occurred at the subject property were observed.

6.2.4 Polychlorinated Biphenyls (PCBs)

No potential PCB-containing equipment (transformers, oil-filled switches, hoists, lifts, dock levelers, hydraulic elevators, etc.) was observed on the subject property during Partner's reconnaissance.

6.2.5 Strong, Pungent or Noxious Odors

No strong, pungent or noxious odors were evident during the site reconnaissance.

6.2.6 Pools of Liquid

No pools of liquid were observed on the subject property during the site reconnaissance.

6.2.7 Drains, Sumps and Clarifiers

No drains, sumps, or clarifiers were observed on the subject property during the site reconnaissance.

6.2.8 Pits, Ponds and Lagoons

No pits, ponds or lagoons were observed on the subject property.

6.2.9 Stressed Vegetation

No stressed vegetation was observed on the subject property.

6.2.10 Additional Potential Environmental Hazards

No additional environmental hazards, including landfill activities or radiological hazards, were observed.

6.3 Non-ASTM Services

6.3.1 Asbestos-Containing Materials (ACMs)

Asbestos is the name given to a number of naturally occurring, fibrous silicate minerals mined for their useful properties such as thermal insulation, chemical and thermal stability, and high tensile strength. The Occupational Safety and Health Administration (OSHA) regulation 29 CFR 1926.1101 requires certain construction materials to be *presumed* to contain asbestos, for purposes of this regulation. Construction materials including, but not limited to, thermal system insulation (TSI), surfacing material, and asphalt/vinyl flooring that are present in a building and that have not been appropriately tested may be considered “presumed asbestos-containing material” (PACM).

Based on the age of the building (1981), there is potential for asbestos-containing materials (ACMs) may be present.

6.3.2 Lead-Based Paint (LBP)

Lead is a highly toxic metal that affects virtually every system of the body. LBP is defined as any paint, varnish, stain, or other applied coating that has 1 mg/cm² (or 5,000 ug/g or 0.5% by weight) or more of lead. Congress passed the Residential Lead-Based Paint Hazard Reduction Act of 1992, also known as “Title X”, to protect families from exposure to lead from paint, dust, and soil. Under Section 1017 of Title X, intact LBP on most walls and ceilings is not considered a “hazard,” although the condition of the paint should be monitored and maintained to ensure that it does not become deteriorated. Further, Section 1018 of this law directed the Housing and Urban Development (HUD) and the US EPA to require the disclosure of known information on LBP and LBP hazards before the sale or lease of most housing built before 1978.

It is unlikely that LBP is present in buildings constructed after 1977. Therefore, due to the age of the subject property building, it is unlikely that LBP is present.

6.3.3 Radon

Radon is a colorless, odorless, naturally occurring, radioactive, inert, gaseous element formed by radioactive decay of radium (Ra) atoms. The US EPA has prepared a map to assist National, State, and local organizations to target their resources and to implement radon-resistant building codes. The map divides the country into three Radon Zones, according to the table below:

EPA Radon Zones		
EPA Zones	Average Predicted Radon Levels	Potential
Zone 1	Exceed 4.0 pCi/L	Highest
Zone 2	Between 2.0 and 4.0 pCi/L	Moderate
Zone 3	Less than 2.0 pCi/L	Low

It is important to note that the EPA has found homes with elevated levels of radon in all three zones, and the US EPA recommends site-specific testing in order to determine radon levels at a specific location. However, the map does give a valuable indication of the propensity of radon gas accumulation in structures.

Radon sampling was not conducted as part of this assessment. Review of the US EPA Map of Radon Zones places the subject property in Zone 2. Based upon the radon zone classification and proposed commercial use, radon is not considered to be a significant environmental concern.

6.3.4 Lead in Drinking Water

According to available information, a public water system operated by the Eastern Municipal Water District (EMWD) serves the subject property vicinity. According to EMWD, the sources of public water for are rivers, lakes, streams, ponds, reservoirs, springs, local groundwater wells, surface water imported from Northern California and the Colorado River. According to the EMWD 2020 Water Quality Report, water supplied to the subject property is in compliance with all State and Federal regulations pertaining to drinking water standards, including lead and copper. There are no current water supplies onsite.

6.3.5 Mold

Molds are microscopic organisms found virtually everywhere, indoors and outdoors. Mold will grow and multiply under the right conditions, needing only sufficient moisture (e.g. in the form of very high humidity, condensation, or water from a leaking pipe, etc.) and organic material (e.g., ceiling tile, drywall, paper, or natural fiber carpet padding).

Partner observed 953 West Nance Street (APN 314-160-015) from West Nance Street and adjoining properties. As such, a mold evaluation was not required by the scope of services.

6.3.6 Wetlands

The subject property does not appear to be a designated wetland area, based on information obtained from the United States Fish & Wildlife Service; however, a comprehensive wetlands survey would be required in order to formally determine actual wetlands on the subject property. No surface impoundments, wetlands, natural catch basins, settling ponds, or lagoons are located on the subject property.

6.4 Adjoining Property Reconnaissance

The adjoining property reconnaissance consisted of observing the adjoining properties from the subject property premises. No items of environmental concern were identified on the adjoining properties during the site assessment, including hazardous substances, petroleum products, ASTs, USTs, evidence of releases, PCBs, strong or noxious odors, pools of liquids, sumps or clarifiers, pits or lagoons, stressed vegetation, or any other potential environmental hazards.

7.0 VAPOR ENCROACHMENT CONDITIONS

Partner conducted a limited non-intrusive vapor screening on the subject property to identify, to the extent feasible, the potential for vapor encroachment conditions (VECs) in connection with the subject property. This included consideration of chemicals of concern (COC) that may migrate as vapors into the subsurface of the subject property as a result of contaminated soil and groundwater on or near the property.

This screening utilized readily available data sources previously discussed in this Phase I ESA that includes:

- the physical setting of the subject property (Section 2.4),
- standard historical sources for the subject property, adjoining, and surrounding area (Section 3.0),
- known or potentially contaminated sites as identified from information from regulatory agencies and sites on Federal, State, tribal and local databases (Section 4.0), and
- information from the site reconnaissance (Section 6.0) of the subject property and observations of the surrounding properties.

The results of our data collection, reconnaissance, and analysis are tabulated below:

<i>Potential for Vapor Encroachment to Impact the Subject Property</i>	
Area of Concern	Likely or Known VEC to Subject Property
Subject Property Existing Operations or Conditions	None identified that impact the subject property.
Historical Uses of the Subject Property	None identified that impact the subject property.
Adjoining Property Operations or Existing Conditions	None identified that impact the subject property.
Historical Uses of Adjoining Properties or Nearby Properties	None identified that impact the subject property.
Regulatory Review of sites identified on Federal, State, tribal and Local Environmental Databases which were located in the AMSD	None identified that impact the subject property.

Based on the findings of the limited non-intrusive vapor screening, vapor intrusion is unlikely to be an issue of concern in connection with the existing structures on the subject property. As such, no further assessment is recommended.

8.0 FINDINGS AND CONCLUSIONS

Findings and Opinions

Recognized Environmental Condition

A *REC* refers to the presence of hazardous substances or petroleum products in, on, or at the subject property due to a release to the environment; the likely presence of hazardous substances or petroleum products in, on, or at the subject property due to a release or likely release to the environment; or the presence of hazardous substances or petroleum products in, on, or at the subject property under conditions that pose a material threat of a future release to the environment. The following was identified during the course of this assessment:

- Partner did not identify any RECs during the course of this assessment.

Controlled Recognized Environmental Condition

A *CREC* refers to a REC affecting the subject property that has been addressed to the satisfaction of the applicable regulatory authority or authorities with hazardous substances or petroleum products allowed to remain in place subject to implementation of required controls (for example, activity and use limitations or other property use limitations). The following was identified during the course of this assessment:

- Partner did not identify any CRECs during the course of this assessment.

Historical Recognized Environmental Condition

A *HREC* refers to a previous release of hazardous substances or petroleum products affecting the that has been addressed to the satisfaction of the applicable regulatory authority or authorities and meeting unrestricted use criteria established by the applicable regulatory authority or authorities without subjecting the subject property to any controls (for example, activity and use limitations or other property use limitations). The following was identified during the course of this assessment:

- Partner did not identify any HRECs during the course of this assessment.

Business Environmental Risk

A *BER* is a risk which can have a material environmental or environmentally driven impact on the business associated with the current or planned use of commercial real estate, not necessarily related to those environmental issues required to be investigated in this practice. The following was identified during the course of this assessment:

- Domestic wastewater generated at the subject property is likely disposed by means of the septic system. The septic system should be abandoned and removed under local requirements when no longer in use.
- Former water wells may be located at the subject property. If encountered in the future, the water wells should be abandoned and removed under local requirements if no longer in use.
- Due to the age of the subject property building, there is a potential that asbestos-containing material (ACM) is present. Suspect ACMs would need to be sampled to confirm the presence or absence of asbestos prior to any demolition activities.

Significant Data Gaps

No significant data gaps affecting the ability of the Environmental Professional to identify a REC were encountered during this assessment.

Conclusions and Recommendations

Partner has performed a Phase I Environmental Site Assessment in conformance with the scope and limitations of ASTM Practice E1527-13 and E1527-21 of the property at the southeast corner of Nance Street and Nevada Avenue in the City of Perris, Riverside County, California (the "subject property"). Any exceptions to, or deletions from, this practice are described in Section 1.5 of this report.

This assessment has revealed no evidence of RECs, CRECs, or HRECs in connection with the subject property; however, BERs were identified. Based on the conclusions of this assessment, Partner recommends no further investigation of the subject property at this time.

9.0 SIGNATURES OF ENVIRONMENTAL PROFESSIONALS

Partner has performed a Phase I Environmental Site Assessment of the property located at the southeast corner of Nance Street and Nevada Avenue in the City of Perris, Riverside County, California in conformance with the scope and limitations of the protocol and the limitations stated earlier in this report. Exceptions to or deletions from this protocol are discussed earlier in this report.

By signing below, Partner declares that, to the best of our professional knowledge and belief, we meet the definition of *Environmental Professional* as defined in §312.10 of 40 CFR §312. Partner has the specific qualifications based on education, training, and experience to assess a *property* of the nature, history, and setting of the subject *property*. Partner has developed and performed all appropriate inquiries in conformance with the standards and practices set forth in 40 CFR Part 312.

Prepared By:

DRAFT

Heather Hodgetts
Senior Scientist

Reviewed by:

DRAFT

Debbie Stott, P.G.
Technical Director

10.0 REFERENCES

Reference Documents

American Society for Testing and Materials, Standard Practice for Environmental Site Assessments: Phase I Environmental Site Assessment Process, ASTM Designation: E1527-13 and E1527-21.

Environmental Risk Information Services (ERIS), Radius Report, July 2022

Federal Emergency Management Agency, Federal Insurance Administration, National Flood Insurance Program, Flood Insurance Map, accessed via internet, July 2022

United States Department of Agriculture, Natural Resources Conservation Service, Web Soil Survey, accessed via the internet, July 2022

United States Environmental Protection Agency, EPA Map of Radon Zones (Document EPA-402-R-93-071), accessed via the internet, July 2022

United States Geological Survey, accessed via the Internet, July 2022

United States Geological Survey Topographic Map, 7.5-minute series, accessed via internet, July 2022

FIGURES

- 1 SITE LOCATION MAP**
- 2 SITE PLAN**
- 3 TOPOGRAPHIC MAP**

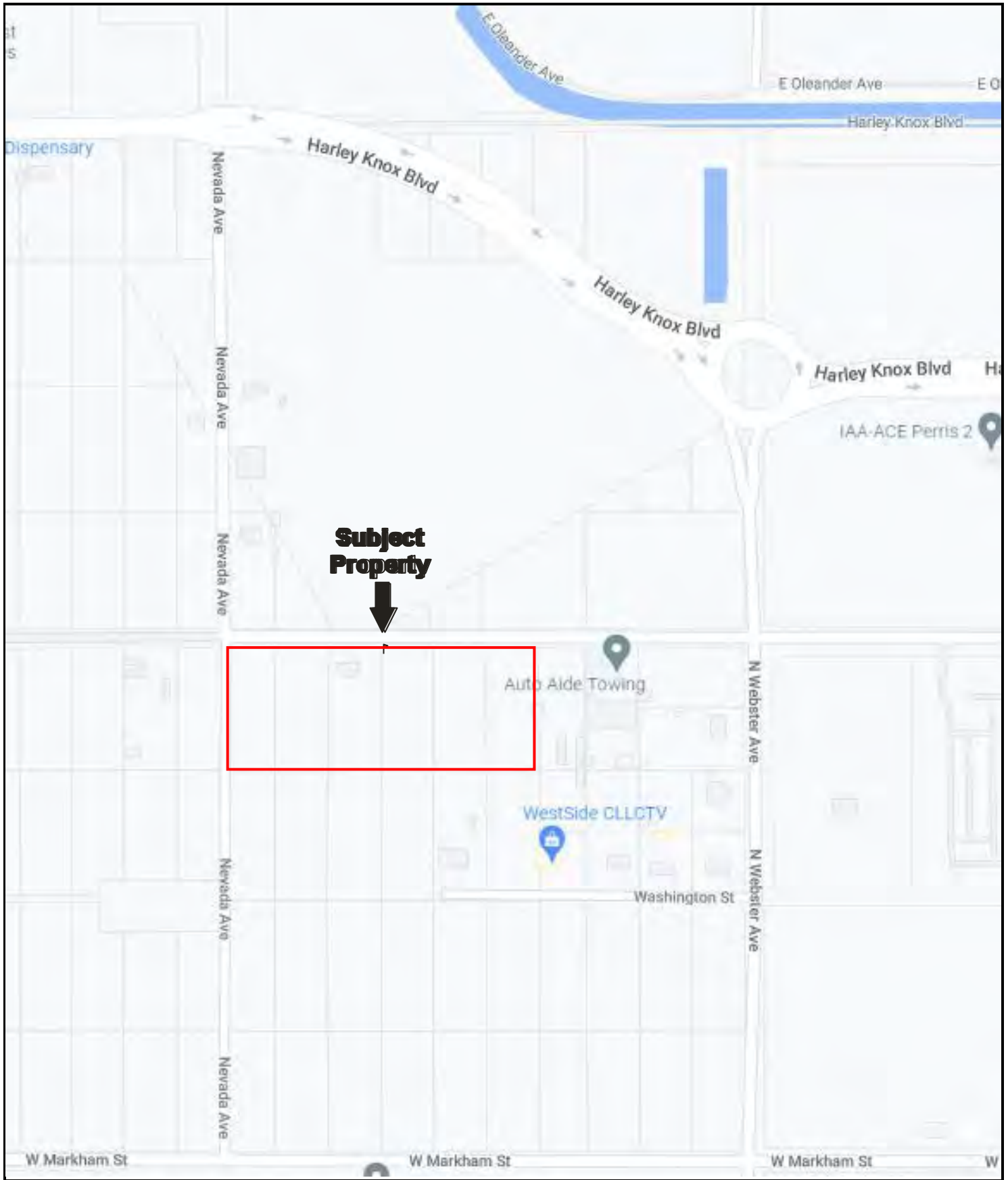

Drawing Not To Scale

KEY:
Subject Property 

FIGURE 1: SITE LOCATION MAP
Project No. 22-378707.1



KEY: - Subject Property
 - Parcel lines
D - Debris and Furniture

FIGURE 2: SITE PLAN
 Project No. 22-378707.1

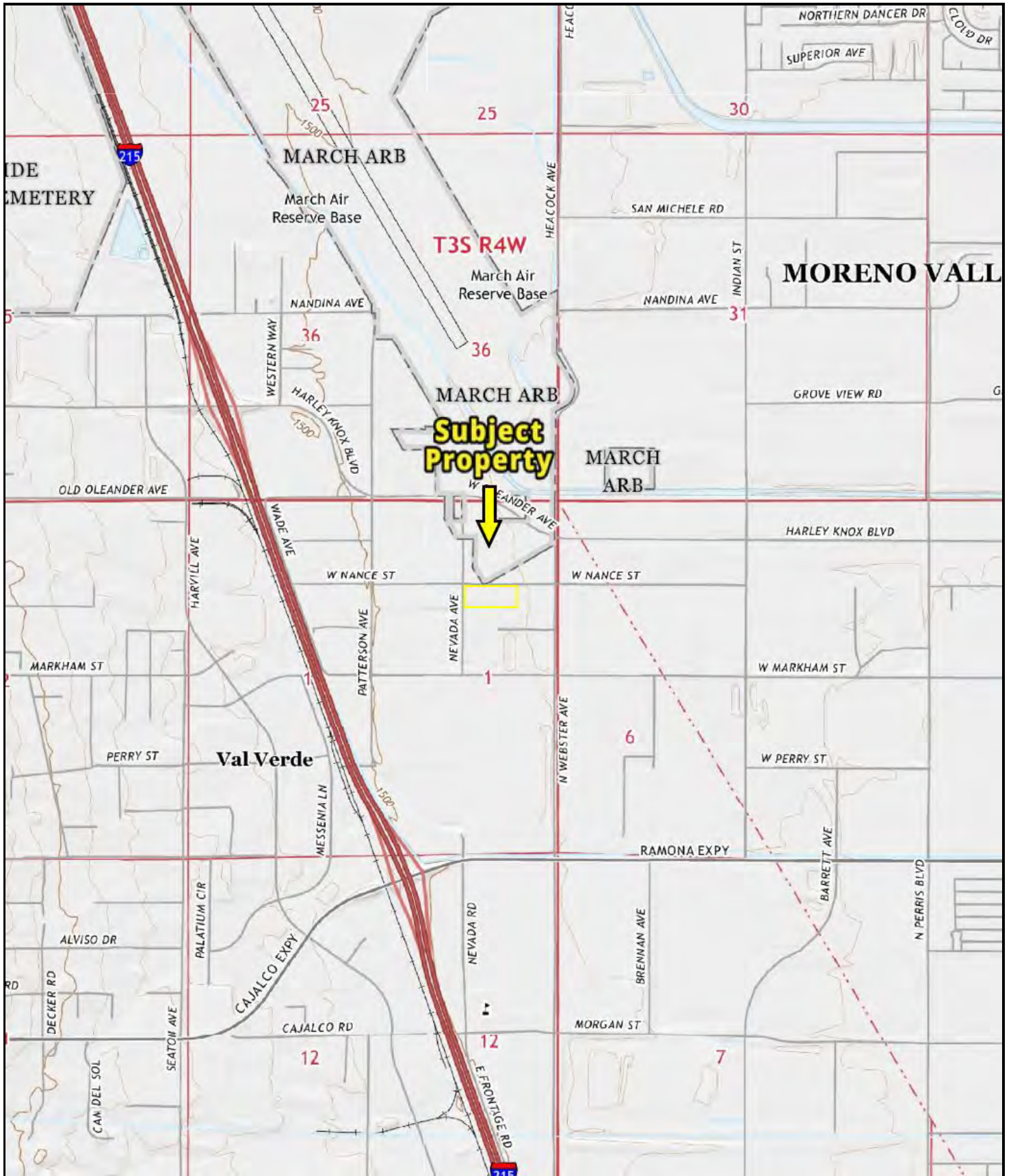

USGS 7.5 Minute Steel Peak, Perris, and Sunnymead, California Quadrangles
 Created: 2021

KEY:
 Subject Property 

FIGURE 3: TOPOGRAPHIC MAP
 Project No. 22-378707.1



APPENDIX A: SITE PHOTOGRAPHS



1. Subject property from the northeast corner of the site, view facing south.



2. Subject property from the northeast corner of the site, view facing southwest.



3. West Nance Street and the adjoining properties to the east, view facing east.



4. West Nance Street and the adjoining properties to the north, view facing northeast.



5. Subject property from the southeast corner of the site, view facing west.



6. Subject property from the southeast corner of the site, view facing northwest.



7. Subject property from the southeast corner of the site, view facing north.



8. The adjoining properties to the east, view facing northeast.



9. The adjoining properties to the south, view facing south.



10. The adjoining properties to the south, view facing southwest.



11. Subject property from the north central boundary, view facing southeast.



12. Subject property from the north central boundary, view facing east.



13. Residence on the north central boundary, view facing southwest.



14. Subject property from the north central boundary, view facing south.



15. Subject property from the north central boundary, view facing southwest.



16. Subject property from the north central boundary, view facing west.



17. Subject property from the northwest corner of the site, view facing southeast.



18. Subject property from the northwest corner of the site, view facing south.



19. The adjoining properties to the west, view facing south.



20. The adjoining properties to the west, view facing west.



21. West Nance Street and the adjoining properties to the northwest, view facing northwest.



22. West Nance Street, Nevada Avenue, and the adjoining properties to the north, view facing north.



23. West Nance Street, Nevada Avenue, and the adjoining properties to the north, view facing northeast.



24. West Nance Street and the adjoining properties to the north, view facing east.



25. Subject property from the southwest corner of the site, view facing east.



26. Subject property from the southwest corner of the site, view facing northeast.



27. Subject property from the southwest corner of the site, view facing north.



28. Debris on the southwest corner of the site, view facing southeast.

Appendix 5: LID Infeasibility

LID Technical Infeasibility Analysis (NOT APPLICABLE)

Appendix 6: BMP Design Details

BMP Sizing, Design Details and other Supporting Documentation

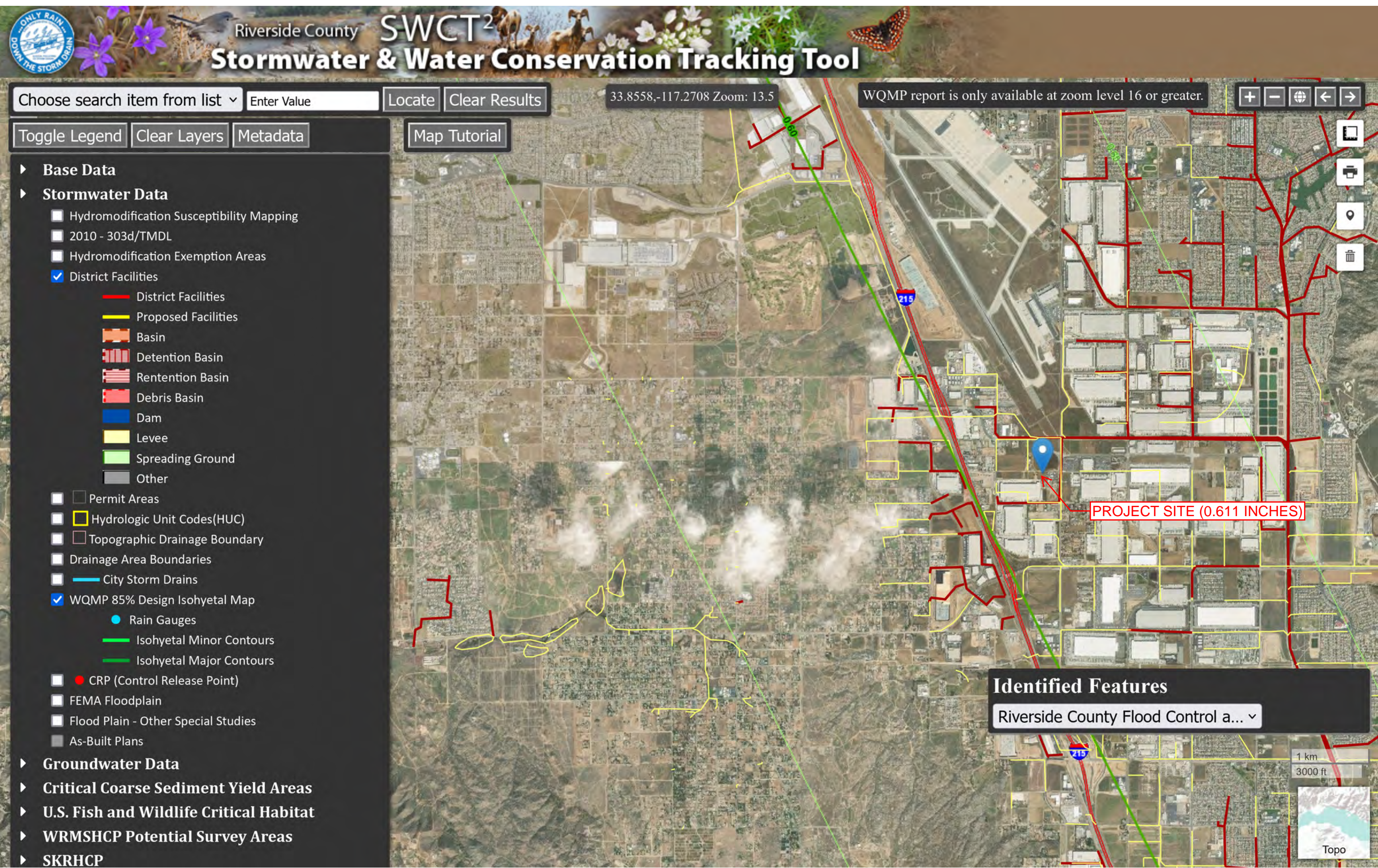

Choose search item from list

33.8558,-117.2708 Zoom: 13.5

WQMP report is only available at zoom level 16 or greater.

- ▶ **Base Data**
- ▶ **Stormwater Data**
 - Hydromodification Susceptibility Mapping
 - 2010 - 303d/TMDL
 - Hydromodification Exemption Areas
 - District Facilities**
 - District Facilities
 - Proposed Facilities
 - Basin
 - ▨ Detention Basin
 - ▨ Rentention Basin
 - ▨ Debris Basin
 - Dam
 - Levee
 - Spreading Ground
 - Other
 - Permit Areas
 - Hydrologic Unit Codes(HUC)
 - Topographic Drainage Boundary
 - Drainage Area Boundaries
 - City Storm Drains
 - WQMP 85% Design Isohyetal Map**
 - Rain Gauges
 - Isohyetal Minor Contours
 - Isohyetal Major Contours
 - CRP (Control Release Point)
 - FEMA Floodplain
 - Flood Plain - Other Special Studies
 - As-Built Plans
- ▶ **Groundwater Data**
- ▶ **Critical Coarse Sediment Yield Areas**
- ▶ **U.S. Fish and Wildlife Critical Habitat**
- ▶ **WRMSHCP Potential Survey Areas**
- ▶ **SKRHCP**

PROJECT SITE (0.611 INCHES)

Identified Features
 Riverside County Flood Control a... ▾

1 km
3000 ft
Topo

Santa Ana Watershed - BMP Design Volume, V_{BMP}

(Rev. 10-2011)

Legend:

Required Entries

Calculated Cells

*(Note this worksheet shall **only** be used in conjunction with BMP designs from the **LID BMP Design Handbook**)*

Company Name **Thienes Engineering, Inc.**

Date **2/21/2023**

Designed by **Luis Prado**

Case No

Company Project Number/Name

TEI 4130 - Perris Trailer Yard

BMP Identification

BMP NAME / ID **STC-A & MWS-A / DMA A**

Must match Name/ID used on BMP Design Calculation Sheet

Design Rainfall Depth

85th Percentile, 24-hour Rainfall Depth,
from the Isohyetal Map in Handbook Appendix E

D_{85} = **0.611** inches

Drainage Management Area Tabulation

Insert additional rows if needed to accommodate all DMAs draining to the BMP

DMA Type/ID	DMA Area (square feet)	Post-Project Surface Type	Effective Imperivous Fraction, I_f	DMA Runoff Factor	DMA Areas x Runoff Factor	Design Storm Depth (in)	Design Capture Volume, V_{BMP} (cubic feet)	Proposed Volume on Plans (cubic feet)
DMA A-1	114562.8	Roofs	1	0.89	102190			
	114562.8				102190	0.61	5203.2	5372

Notes:
Tributary Area = 2.63
Assume 100% Impervious

MWS VOLUME BASED SIZING SHEET

Project Information

Project ID	
Project Name	Perris Trailer Yard (DMA A)
Project Location	Nance Street and Nevada Ave., Perris, CA
Date	2/21/2023



Horizontal Flow Biofiltration System

SIZING CALCULATIONS

Impervious Area

	Inputs	Units
BMP Drainage Area <small>(not required - manual entry - not part of formula)</small>	2.63	Acres
Watershed Impervious Ratio <small>(not required - manual entry - not part of formula)</small>		
Runoff Coefficient "C" <small>(not required - manual entry - not part of formula)</small>		

Notes/References

This includes all areas that will contribute runoff to the proposed BMP, including pervious areas, impervious areas, and off-site areas, whether or not they are directly or indirectly connected to the BMP.

Watershed Imperviousness Ratio", is equal to the percent of total impervious area in the "BMP Drainage Area" divided by 100

Water Quality Volume (required)	5203	cubic feet
Design Storm Duration	0	hours

Use sizing procedures provided by state or local agencies to determine the appropriate Water Quality Volume. Intensities and design storms vary widely by region and method.

Varies depending on geographical region. Set at 0 for pump system set up. LA County 3 hours. Call for details.

MWS Sizing

WetlandMod Model Number (from matrix)	MWS-L-4-8	
HGL	3.4	
# Of Units	1	quantity
Discharge Rate (from matrix)	13.08	gallons/minute

Please choose size from "Model Size Matrix" Tab

Treatment Hydraulic Grade Line

Select the number of systems required to treat the water quality volume. Will vary depending on drain down time regulations.

Loading Rate of 0.26 gpm/sq ft or 25 in/hr. Field Verified.

Volume Treated During Event

Processed through MWS - Linear	0	cubic feet	13.0832 gals/minute
--------------------------------	----------	-------------------	----------------------------

Volume Treated Following Event

MWS Static Capacity (from matrix)	80.51	cubic feet
Volume Needed in Pre-Storage	5122	cubic feet

Set at zero to start. Size pre-storage system to hold this volume

Sizing complete when equal to value of zero.

TOTAL STORMWATER TREATED	5203	cubic feet
Drain Down Time	49.71	hours

Note: This amount should be equal to the "Water Quality Volume"

Drain down time must be equal to or less than requirement of local jurisdiction. Default 48 hours.

Feel free to call or email proposed sizing calculations to Modular Wetlands Systems for assistance with sizing, compliance, and design.

Phone: 1-800-338-1122

Email: info@conteches.com





StormTech
Detention • Retention • Recharge
 Subsurface Stormwater Management™

MC-3500 Site Calculator

Project Information:
 Project Name: Perris Trailer Yard (DMA A)
 Location: Perris, CA
 Date: 21-Feb
 Engineer: Thienes Engineering, Inc.
 StormTech RPM:

System Requirements		
Units	Imperial	
Required Storage Volume	5122	CF
Stone Porosity (Industry Standard = 40%)	40	%
Stone Above Chambers (12 inch min.)	12	inches
Stone Foundation Depth (9 inch min.)	9	inches
Average Cover over Chambers (24 inch min.)	24	inches
Bed size controlled by WIDTH or LENGTH?	WIDTH	
Limiting WIDTH or LENGTH dimension	25	feet
Storage Volume per Chamber	178.9	CF
Storage Volume per End Cap	46.9	CF

System Sizing		
Number of Chambers Required	28	each
Number of End Caps Required	6	each
Bed Size (including perimeter stone)	1,636	square feet
Stone Required (including perimeter stone)	301	tons
Volume of Excavation	333	cubic yards
Non-woven Filter Fabric Required (20% Safety Factor)	582	square yards
Length of Isolator Row	76.4	feet
Non-woven Isolator Row Fabric (20% Safety Factor)	132	square yards
Woven Isolator Row Fabric (20% Safety Factor)	168	square yards
Installed Storage Volume	5,291	cubic feet

Controlled by Width (Rows)		
Maximum Width =	25	feet
1 row of	10	chambers
2 row of	9	chambers
Maximum Length =	76.44	feet
Maximum Width =	22.75	feet

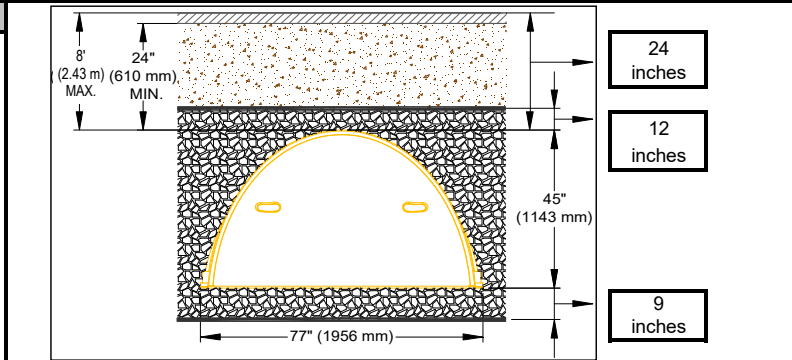



*This represents the estimated material and site work costs (US dollars) for the project. Materials excluded from this estimate are conveyance pipe, pavement design, etc. It is always advisable to seek detailed construction costs from local installers. Please contact STORMTECH at 888-892-2694 for additional cost information.

Appendix 7: Hydromodification

Supporting Detail Relating to Hydrologic Conditions of Concern

HCOC MAP

Legend

-  NOT SUSCEPTIBLE
-  SUSCEPTIBLE

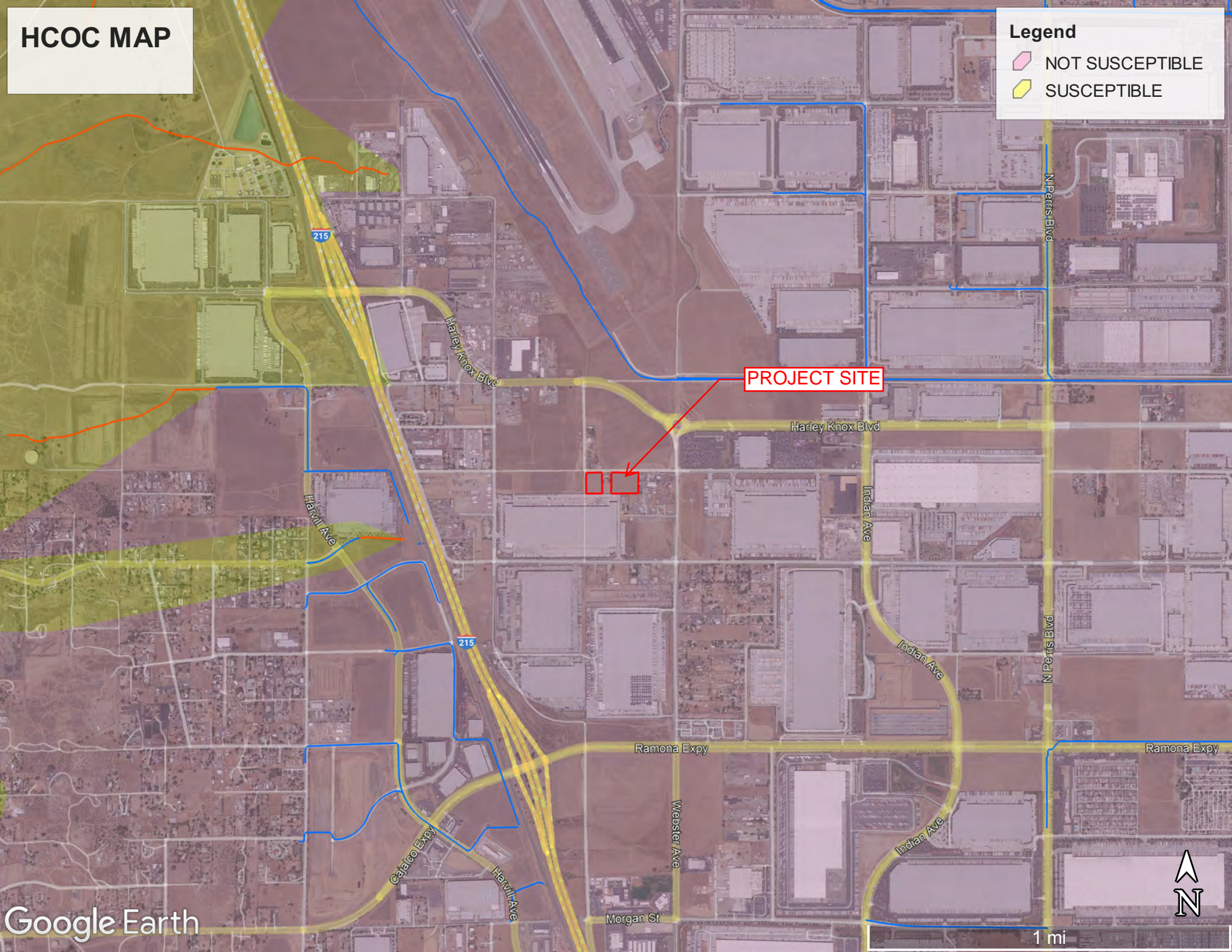

PROJECT SITE

Appendix 8: Source Control

Pollutant Sources/Source Control Checklist

Appendix 9: O&M

Operation and Maintenance Plan and Documentation of Finance, Maintenance and Recording Mechanisms

Appendix 10: Educational Materials

BMP Fact Sheets, Maintenance Guidelines and Other End-User BMP Information